

6 MT BACKPLANE CONNECTOR-PLUG Blind-Mate Optical Connector

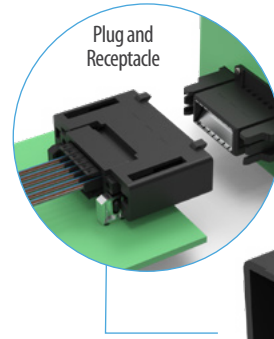

6 MT Backplane Connector
Plug

SENKO's Optical Backplane connector with AirMT™ technology represents a cutting-edge solution for high-speed data centers and rugged environments. This connector, designed to meet the demands of next-generation architectures, offers exceptional optical performance and stability. Leveraging blind mating technology, it seamlessly connects up to 144 fibers using 24F MT ferrules. The key features include high-density MT connectivity, which optimizes space utilization, and a lower mating force compared to traditional MPO connectors, ensuring ease of installation and reliable connections. With both 6 x 12F and 6 x 24F ferrule options, it provides flexibility for various applications. Additionally, the inner shutter mechanism enhances eye safety during handling and maintenance. Whether you're designing CPO Switches or deploying optical interconnects in rugged environments, SENKO's Optical Backplane connector delivers unparalleled performance and reliability

FEATURES

- High density MT connectivity
- Lower mating force vs MPO
- Accommodates 6 x 12F & 6 x 24F ferrule options
- AirMT technology compatible

APPLICATIONS

- Data center
- Co-packaged optics (CPO)
- On board optics
- Optical cross connect
- Telecommunications

KEY BENEFITS

- ✓ **Blind mate**
- ✓ **High fiber count**
- ✓ **High durability**
- ✓ **Low Spring force with AirMT technology**

Mechanical Data

	Value
Durability	50 matings per GR-1435-CORE 200 matings for AirMT ferrule
Fixing Method	Screw mount
Housing Material Type	Plastic
Dust Protection Method	Removeable dust caps

Optical Data

Parameters	Singlemode		Multimode	
	APC		MM	
	Low Loss	Standard	Low Loss	Standard
Typical Insertion Loss (dB)* 12-fiber	0.10	0.20	0.08	0.15
Max. Insertion Loss (dB)* 12-fiber	0.25	0.70	0.25	0.50
Typical Insertion Loss (dB)* 12-fiber <i>With non-contact technology</i>	0.10	0.20	0.08	0.15
Max. Insertion Loss (dB)* 12-fiber <i>With non-contact technology</i>	0.25	0.70	0.25	0.50
Typical Insertion Loss (dB)* 24-fiber <i>With non-contact technology</i>	0.25	0.35	0.15	0.20
Max. Insertion Loss (dB)* 24-fiber <i>With non-contact technology</i>	0.50	1.00	0.35	0.50
Typical Return Loss (dB)	≥55		≥25	

* Specifications provided are targeted only based on master grade jumper to low loss random mating test

Environmental Data

	Value
Operating Temperature (C)	-40°C to +75°C
RoHS Compliance	2015/863 RoHS
REACH Compliance	Yes
Humidity Resistance	95%

6 MT BACKPLANE CONNECTOR - PLUG

Blind-mate optical connector

Connector Drawing

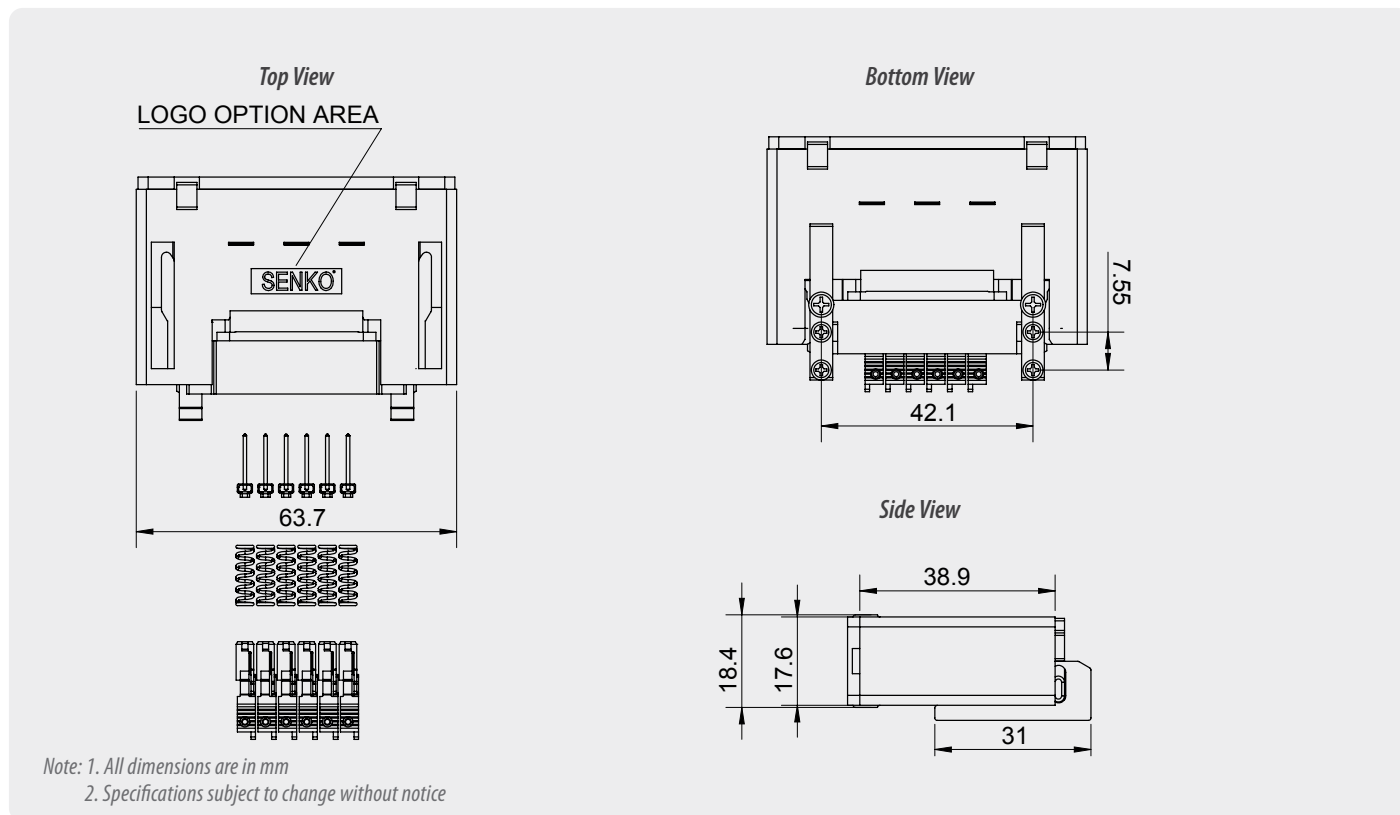

ORDERING

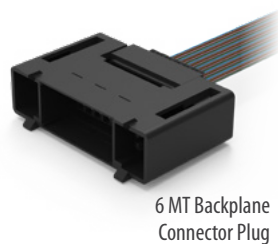

BACKPLANE CODE		MT PORT COUNT		GUIDE PIN		SPRING		SHUTTER		LOGO	
BAPP	Plug	06	6 Ports	LL	SM Low Loss	05N1	5N Oen Spring	00	No Shutter	N	No Logo
				SM	SM	05N2	5N Closed Spring			L	SENKO Logo
				MM	MM	10N2	10N Closed Spring				

BAPP - 06LL - 05N1 - 00N ORDER CODE example

SENKO[®]

Advanced Components

sales@senko.com
1-858-623-3300

senko.com/contact