



Indoor/outdoor
applications



Easy assembly



Maximize your
saving

Smart Solutions
for the Fiber Optic Industry

HARSH ENVIRONMENT PRODUCTS

HARSH ENVIRONMENT PRODUCTS

- IP SERIES pg. 06
- XP FIT PLUS pg. 08
- IP ONE pg. 10
- IP SERIES WITH SAFE LOCK pg. 14
- IP FAN OUT KIT pg. 16
- IP DISTRIBUTION BOX pg. 20
- CTJ BOX pg. 22

HARSH ENVIRONMENT ACCESSORIES

- FAN OUT DISTRIBUTION AND DEMARCATION pg. 25
- PSA PRE-TERMINATION KIT pg. 26
- RUGGEDIZED FAN-OUT pg. 27
- SMART CLEANER pg. 28
- SMART PROBE pg. 30
- SMART CHECKER pg. 31

Senko's Harsh Environment IP Product Range

Connecting your challenging Communications



Carrier Class
WiFi Applications



Telecom
Applications

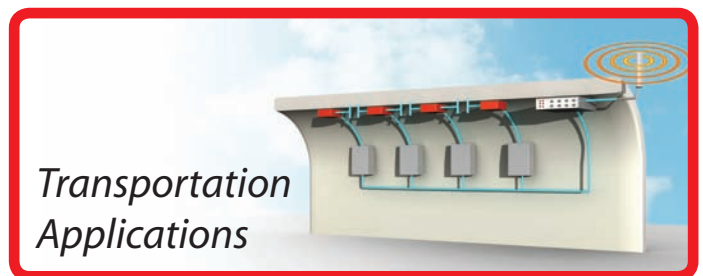

Transportation
Applications

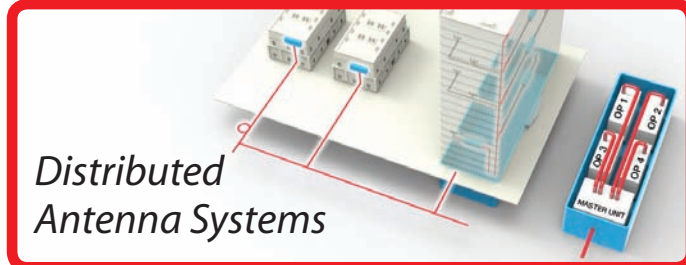

Distributed
Antenna Systems



Small Cell Systems

- Markets**
- Broadcast
 - Commercial
 - Domestic
 - Education
 - Medical
 - Maritime
 - Military
 - Oil and Gas
 - Telecoms
 - Transport
 - Renewable Energy

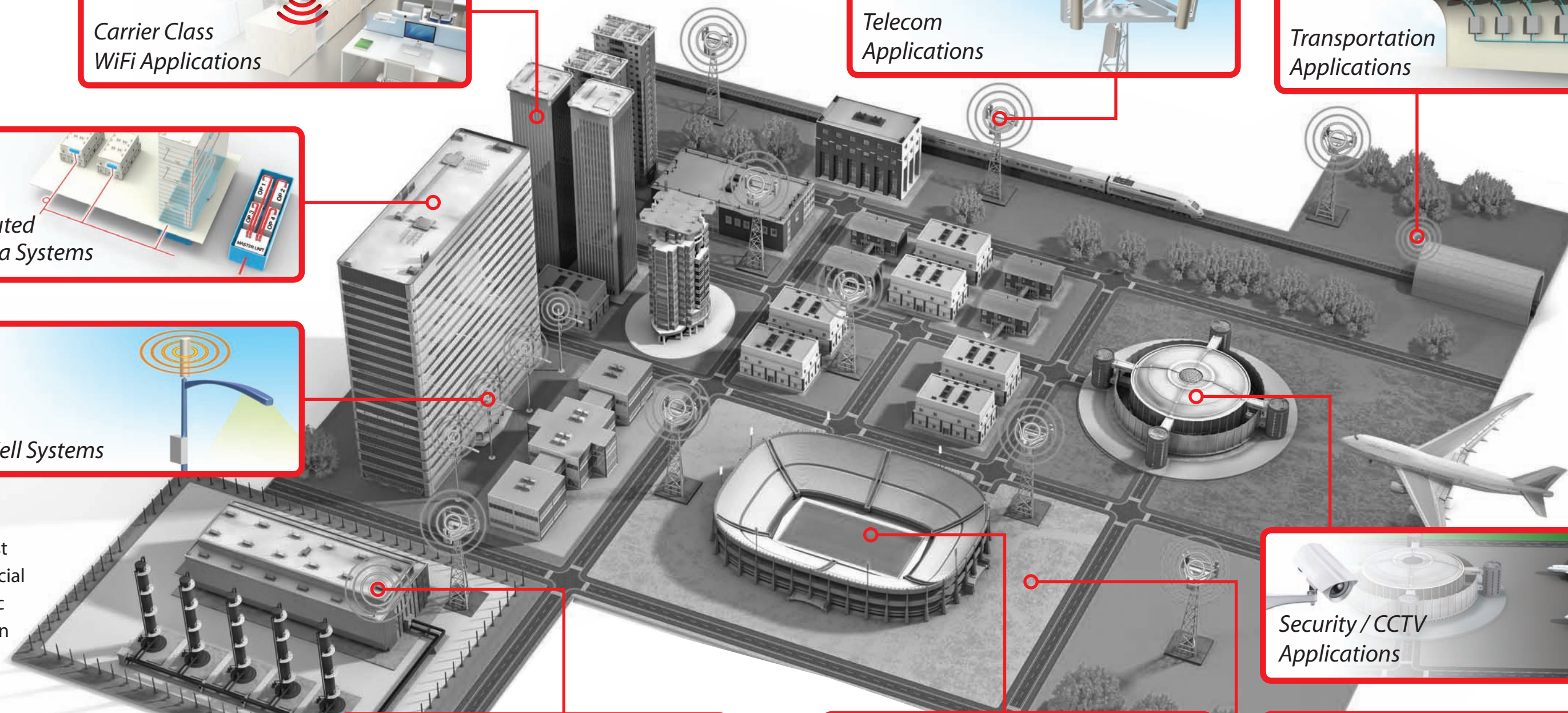

Industrial/Oil/Gas
Applications



Stadium / Large Venue
Applications



Security / CCTV
Applications



Broadcast
Applications

IP-Series Weatherproof Connector

The SENKO harsh environment (IP) range of connectors are designed to be used outdoor and provide many years of reliable service. They incorporate a bayonet system which enables quick and reliable installation even when engineers are wearing gloves.



Exceed ODVA requirements



Simple bayonet locking system



Low Insertion Loss

Withstand the Elements

FTTA

Simple connectivity solution with fiber for LTE, DAS, and Mobile Cell tower

CTJ
Distribution Box



Fan Out Kits



Plug and Play Fan Out

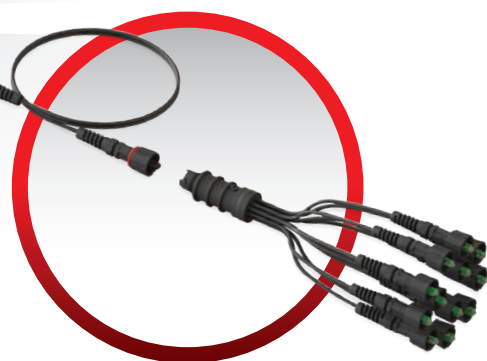

IP-Series GOES HYBRID

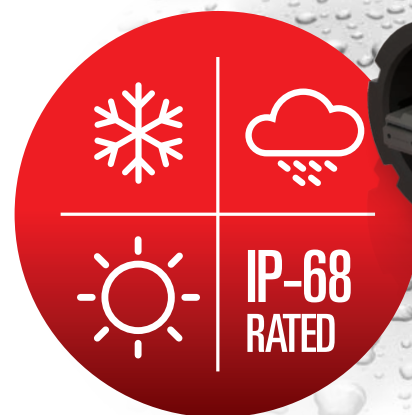

FEATURES

- Cost effective solution for in house termination
- IP water immersion and dust protection for harsh environment
- Wide range of operational temperature for outside plant -40°C/70°C
- Compatible with a wide range of cables, 5-8mm OD cable with two 2.0mm to 3.0mm jacketed subunits
- Chemical Resistance
- Intermateable to other Industrial LC adaptor per IEC 60603-7
- Simple assembly requiring no special tools
- Durable mechanical mating
- The XP versions allow installers to terminate connectors in the field
- ODVA Compatible
- 100lbs Superior pull force
- Patent design
- Feed-through

APPLICATIONS

- Telecoms
- Broadcast
- Commercial
- Domestic
- Education
- Medical
- Maritime
- Military
- Oil and Gas
- Transport
- Renewable Energy

TYPICAL CHARACTERISTICS	IP-LC		IP-SC		IP-MPO Low Loss		IP-MPO	
	SM	MM	SM	MM	SM (Low loss)	MM (Low loss)	SM	MM
Insertion Loss (Max)	0.2 dB	0.2 dB	0.2 dB	0.2 dB	0.35 dB	0.3 dB	0.7 dB	0.5 dB
Insertion Loss (Average)	0.08 dB	0.1 dB	0.08 dB	0.1 dB	0.1 dB	0.08 dB	0.2 dB	0.1 dB
Return Loss	55 dB	NA	55 dB	NA	60 dB (Angle)	25 dB (Flat)	60 dB (Angle)	25 dB (Flat)
Durability	50 matings							
Operating Temperature	-40°+70°							
IP Rating	IP-68							
Pull Force	100 lbs							
Material	UV resistant							

Note: SENKO LC and SC connectors are designed and tested to meet IEC Random Mating Grade B (≤0.12dB mean, ≤0.25dB max for >97% of sample)
IP-MPO is available up to 24 Fibers
Loss value is based on 12F low loss ferrule

IP-ONE
Optical 'N' Electrical
Power/Fiber combined



IP-ONE®

Optical 'N' Electrical
Power/Fiber combined

Industrial rated IP-68
Hybrid Connector

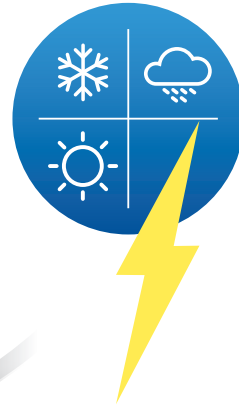

Reduce
installation time



Indoor/outdoor
applications



Space Saving



Cost Effective

IP-68
rated
housing

OPTICAL
+

ELECTRICAL



IP-ONE MPO

IP-ONE LC Duplex

SENKO's Simple Maths:

ONE connector makes installation
Simple, Quick, and Cost effective

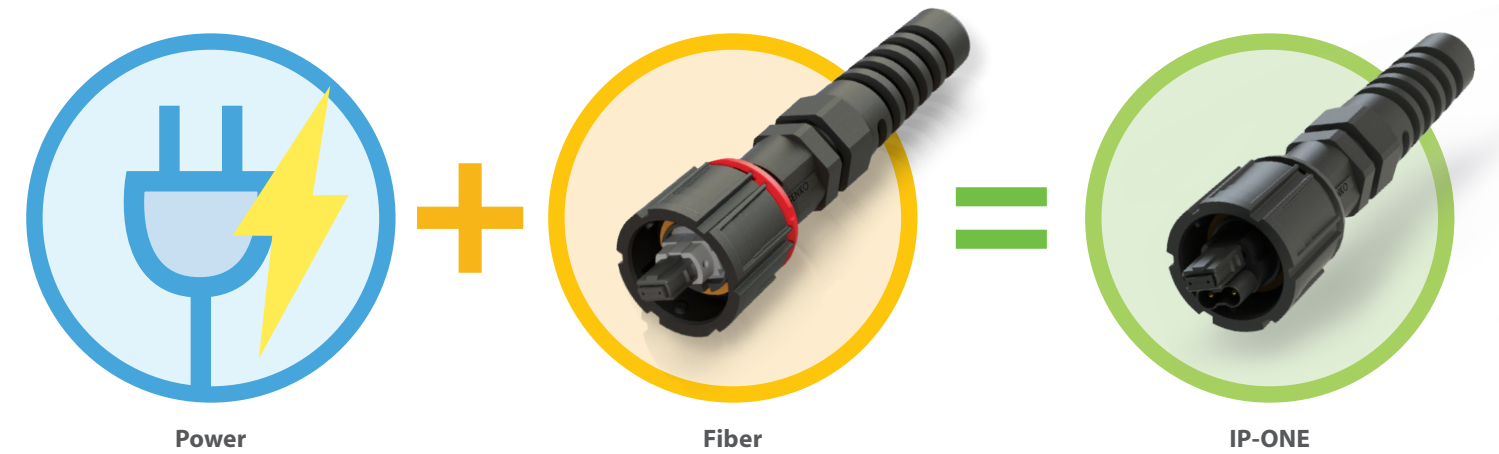

Tamper Proof your Connectivity with IP-Safe Lock



Anywhere you need fiber and power



IP-ONE®

Optical 'N' Electrical Power/Fiber combined

Industrial rated IP-68
Hybrid Connector

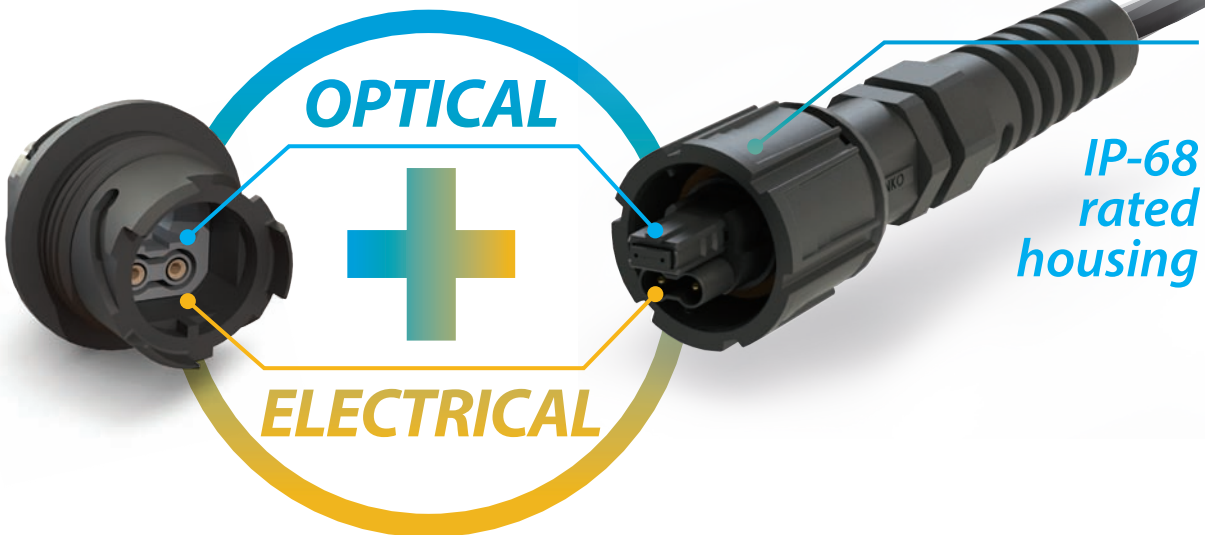

IP-68
rated
housing



Reduce
installation time



Indoor/outdoor
applications

One single connector providing power and optical connectivity to your equipment.

FEATURES

- Combined power and fiber in ONE connector
- Simplify your connectivity with reduced cable and connectors
- Minimize interface footprint of your equipment
- Provide reliable protection in outside plant, Rating IP-68
- Cost effective with easy termination
- Tamper proof with SENKO Safe Lock
- Reduced and simplified connectivity
- DC Power distance - 1Km (-48V, 40W over 12 AWG cable)

TYPICAL CHARACTERISTICS	IP-ONE LC		IP-ONE MPO Low Loss		IP-ONE MPO	
	SM	MM	SM (Low loss)	MM (Low loss)	SM	MM
Insertion Loss (Max)	0.2 dB	0.2 dB	0.35 dB	0.3 dB	0.7 dB	0.5 dB
Insertion Loss (Average)	0.08 dB	0.1 dB	0.1 dB	0.08 dB	0.2 dB	0.1 dB
Return Loss	55 dB	NA	60 dB (Angle)	25 dB (Flat)	60 dB (Angle)	25 dB (Flat)
Durability	50 matings					
Operating Temperature	-40°+70°					
IP Ratings	IP-68					
Pull Force	100 lbs					
Material	UV resistant					
Power Rating						
DC	100V 9.3A 930 Watts (12AWG)					
AC	Max AC 240V 4.8A 1.15Kwatts (12AWG)					



IP-ONE LC Connector

CODE	TYPE	POWER CONTACT	CONNECTOR BODY	SAFE LOCK RING	DUST CAPS
IP1-LC	LSM Blue 125µm	P Pin (Male)	X 4.5-7.2mm	00 with	D with
	LAPC Green 125µm	S Socket (Female)	E 7.5-11mm	01 without	None without
	LMM Beige 127µm				

IP1-LC - LSM - P - X - 00 - D Order Code Example



IP-ONE LC Adapter

ADAPTER CODE	TYPE	DUST CAPS
IP1-LC	AP Pin (Male)	D with
	AS Socket (Female)	None without

IP1-LC - AS - D Order Code Example

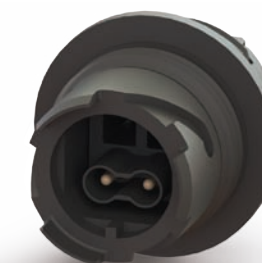

IP-ONE MPO Connector

CODE	TYPE	POWER CONTACT	GENDER	N. OF FIBERS	CONNECTOR BODY	SAFE LOCK RING	DUST CAPS
IP1-MPO	LML MM Low Loss	P Pin	F Female	1 12F	X 4.5-7.2mm	00 with	D with
	LMM MM Standard	(Male)	M Male	2 24F	E 7.5-11mm	01 w/o	None w/o
	LSL SM Low Loss	S Socket					
	LSM SM Standard	(Female)					

IP1-MPO - LSL - P - F1 - X - 01 - D Order Code Example



IP-ONE MPO Adaptor

ADAPTER CODE	TYPE	DUST CAPS
IP1-MPO	AP Pin (Male)	D with
	AS Socket (Female)	None without

IP1-MPO - AP Order Code Example

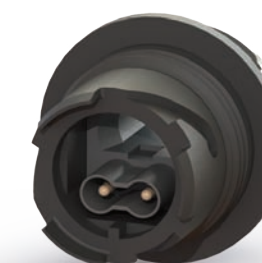

IP-Series with Safe LOCK Weatherproof Connector



1 Standard Connection:
Twist the bayonet nut



2 Safe Lock:
Slide the ring into the nut



Bayonet is locked and will prevent any turning or loosening

With all the benefits of the SENKO IP Connector range this new addition to the IP connectivity family with its secondary lockable ring provides extra security and reduces the opportunity for tampering.

Option:



Safe Lock ready
Connector body without ring



Retro Fit Safe Lock
Add Safe Lock ring as needed in field



Multiple colors for Identification

TYPICAL CHARACTERISTICS	IP-LC		IP-SC		IP-MPO Low Loss		IP-MPO	
	SM	MM	SM	MM	SM (Low loss)	MM (Low loss)	SM	MM
Insertion Loss (Max)	0.2 dB	0.2 dB	0.2 dB	0.2 dB	0.35 dB	0.3 dB	0.7 dB	0.5 dB
Insertion Loss (Average)	0.08 dB	0.1 dB	0.08 dB	0.1 dB	0.1 dB	0.08 dB	0.2 dB	0.1 dB
Return Loss	55 dB	NA	55 dB	NA	60 dB (Angle)	25 dB (Flat)	60 dB (Angle)	25 dB (Flat)
Durability	50 matings							
Operating Temp.	-40°+70°							
IP Rating	IP-68							
Pull Force	100 lbs							
Material	UV resistant							

Safe Lock Ring

RETRO FIT RING	COLOR
IP-LRR	01 Blue
	02 Black
	03 Green
	04 Red
	05 Yellow

Order Code Example: IP-LRR - 01

Note: SENKO LC and SC connectors are designed and tested to meet IEC Random Mating Grade B (≤ 0.12 dB mean, ≤ 0.25 dB max for >97% of sample)
IP-MPO is available up to 24 Fibers
Loss value is based on 12F low loss ferrule



IP-LC^{PLUS}

CONNECTOR CODE	TYPE		CRIMP SET		SAFE LOCK RING		DUST CAPS	
IP-LC	LSM	Blue 125 μ m	4.8	4.5-4.9mm	00	with	D	with
	LAPC	Green 125 μ m	5.x	5.3-5.7mm	01	without	None	without
	LMM	Beige 127 μ m	6.0	5.8-6.2mm				
	LMM10G	Aqua 127 μ m	7.0	6.8-7.2mm				
			E	7.5mm-11mm				

Order Code Example: IP-LC - LMM - 7.0 - 00 - D



IP-SC^{PLUS}

CONNECTOR CODE	TYPE		CRIMP SET		DUST CAPS	
IP-SC	LSM	Blue 125 μ m	4.8	4.5-4.9mm	D	with
	LAPC	Green 125 μ m	5.x	5.3-5.7mm	None	without
	LMM	Beige 127 μ m	6.0	5.8-6.2mm		
			7.0	6.8-7.2mm		
			E	7.5mm-11mm		



IP-MPO

CODE	TYPE	GENDER	N. OF FIBERS	CRIMP SET		SAFE LOCK RING		DUST CAPS			
IP-MPO	LMLL	MM Low Loss	F Female	1	12F	4.8	4.5-4.9mm	00	with	D	with
	LMM	MM Standard	M Male	2	24F	5.x	5.3-5.7mm	01	w/o	None	w/o
	LSLL	SM Low Loss				6.0	5.8-6.2mm				
	LSM	SM Standard				7.0	6.8-7.2mm				
				E	7.5mm-11mm						



IP-LC^{PLUS} Adapter

CODE	ADAPTOR TYPE				DUST CAPS	
IP-LC	LA	Bulk Head	4S11	SM BLUE	D	with
	LAI	In-line	4S31	APC Green	None	without
	SLAI	Streamline Inline	4S81	MM Beige		

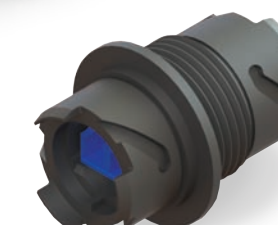

IP-SC^{PLUS} Adapter

CODE	ADAPTOR TYPE				DUST CAPS	
IP-SC	LA	Bulk Head	131	Black Universal	D	with
	LAI	In-line			None	without
	SLAI	Streamline Inline				

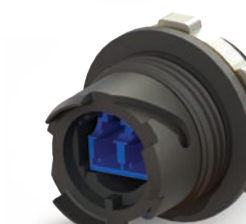

MPO^{PLUS} Adapter

CODE	ADAPTOR TYPE				DUST CAPS	
IP-MPO	LA	Bulk Head	779	Black Universal	D	with
	LAI	In-line			None	without
	SLAI	Streamline Inline				



XP Fit Plus™ Field Installable Connector



Easy installation
in under 2 minutes

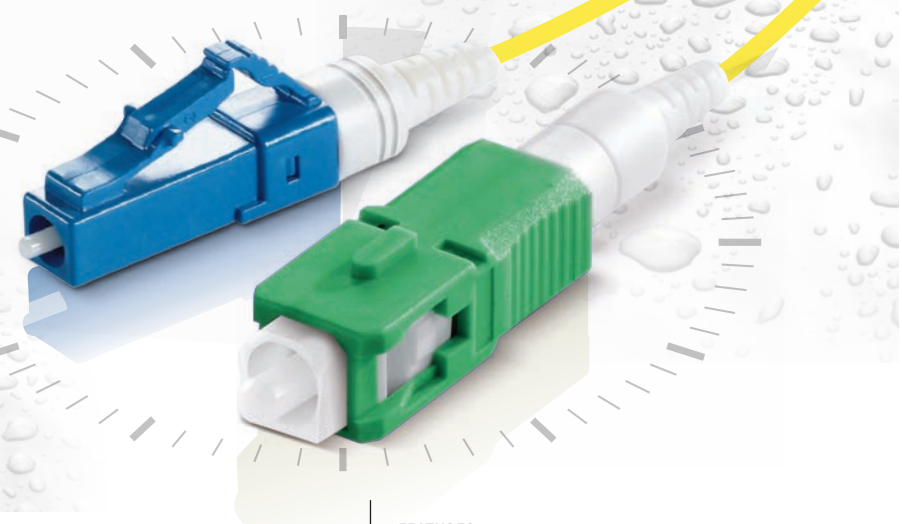

Maximize
your saving



Easy
assembly



RoHS and
UL 94 V-0
compliant

IP-LC XP

CONNECTOR CODE	CONNECTOR TYPE	TYPE	CABLE	SAFE LOCK RING	DUST CAPS	
IP-LCFT	1	XPFit Plus	LSM Blue	4.8 4.5-4.9mm	00 with	D with
			LOM1 Beige	5.X 5.3-5.7mm	01 without	None without
			LMO3 Aqua	6.0 5.8-6.2mm		
				7.0 6.8-7.2mm		
			E	7.5-11mm		

IP-LCFT - 1 - LSM - E - 00 - D Order Code Example

FEATURES

- Mechanical Splice (index matching gel)
- Highly Stable & Reliable
- Perfect Performance
- Compact Package
- RoHS Compliant
- Connector meets UL94-V0 Flammability Rated



IP-SC XP

CONNECTOR CODE	CONNECTOR TYPE	TYPE	CABLE	SAFE LOCK RING	
IP-SCFT	1	XPFit Plus	LSM Blue	4.8 4.5-4.9mm	00 with
			LAPC Green	5.X 5.3-5.7mm	01 without
			LMO1 Beige	6.0 5.8-6.2mm	
			LMO2 Black	7.0 6.8-7.2mm	
			LMO3 Aqua	E 7.5-11mm	
	F	2X3mmDC			

IP-LCFT - 1 - LSM - E - 00 Order Code Example

Installation KIT

XP Fit Installation KIT
content detail

- 1 Soft Case
- 2 Fibre Disposal Unit
- 3 Lint Free Wipes
- 4 Standard Cleaver
- 5 Smart Checker
- 6 Buffer Remover
- 7 Launch cables
- 8 Fiber Stripper
- 9 Kevlar scissors



Premium Cleaver Flat



Standard Cleaver Flat



Precision Cleaver Angled

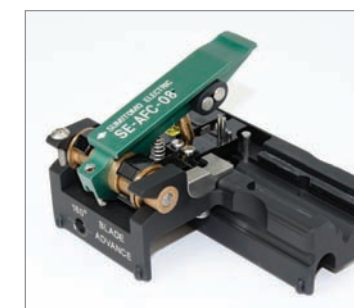

IP-Fan Out Kits



- Weatherproof
- Dustproof



The harsh environment (IP) distribution Fan-Out range is designed to be used outdoor and provide many years of reliable service. They incorporate the SENKO IP range of Connectors and Adaptors and can be configured either for initial or with redundancy for future connectivity requirements.

APPLICATIONS

- Telecoms
- Broadcast
- Commercial
- Domestic
- Education
- Medical
- Maritime
- Military
- Oil and Gas
- Transport
- Renewable Energy

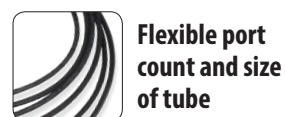

SPECIFICATIONS

Fixing	Hose Clip / Cable Tie	IP Rating	IP-68
Number of Fibers	2 to 24 *	Tensile Rating	Feeder Side: 100 lbs (450N)
Suitable for Connector Types	IP-LC, IP-SC, IP-MPO		Fan-Out Side: 50 lbs (222N)
Temperature Range	-40°C to +85°C		

* Note: using MPO connector only

Fan Out Kit

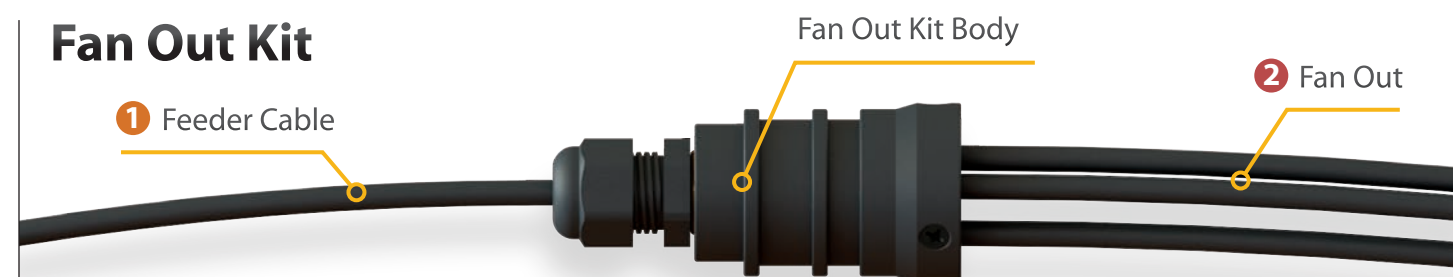

CODE	① FEEDER CABLE OD	② DRUM (PORT x Tube OD)
IP-FO-S2	1 4.5-4.9mm	A 3x4.8
	2 5.3-5.7mm	B 6x4.8*
	3 5.8-6.2mm	C 12x3.0
	4 6.8-7.2mm	D 24x2.0

IP-FO-S2 - 1 - B Order Code Example

CODE	① FEEDER CABLE OD	② DRUM (PORT x Tube OD)
IP-FO-S2-5	7.3-12.0mm	A 3x4.8
		B 6x4.8*
		C 12x3.0
		D 24x2.0

IP-FO-S2-5 - B Order Code Example

Body Size: ref 75mm x 34mm

Fan Out Kit



CODE	① FEEDER CABLE OD	② DRUM (PORT x Tube OD)
IP-FO-M-1	7.3-12.0mm	A 6x7.0
IP-FO-M-2	12.1-18.0mm	B 9x4.8
		C 12x4.8
		D 24x3
		E 6x4.8

IP-FO-M-1 - B Order Code Example

Body Size: ref 100mm x 39mm

Typical Application

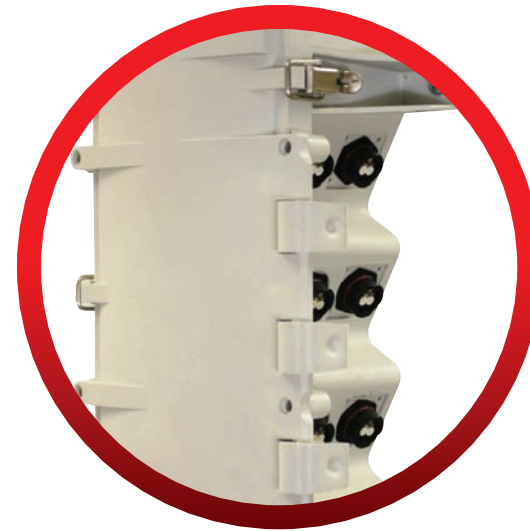
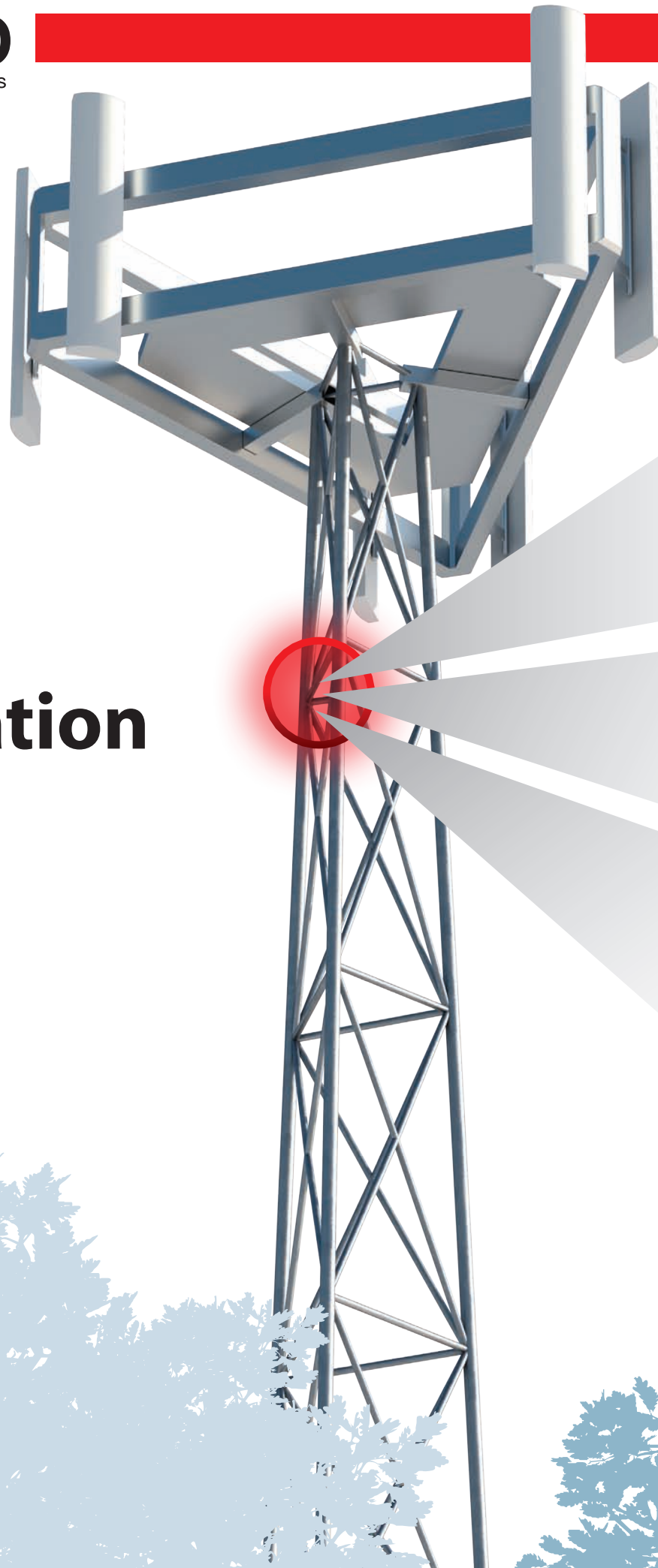

CTJ Distribution Box

The SENKO CTJ Distribution Box range caters for a number of applications providing clear demarcation. Ideal for either combined or separate Fiber / Power applications these Boxes can also house additional functionality such as Surge Protection and DC breakers. A range of labeling and mounting brackets complete the package.

(See page 20-22)

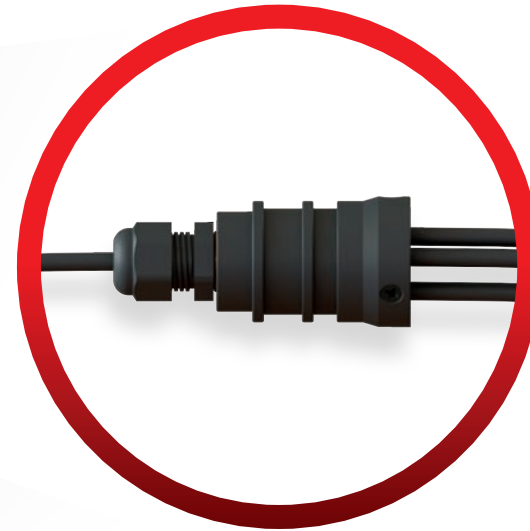

Fan Out Kits

SENKO's wide range of harsh environment (IP) Fan-Out kits are ideal for large repeatable rollout programs. These kits enable factory assembly of your fiber connectivity ensuring low loss high performance together with minimum on-site installation activity. The configurations range from simple 3 lead fan-outs to complex multi-bundled fiber cables. Fan-out furcation tubes can be adapted to your unique requirement.

(See page 16-17)



Plug and Play Fan Out

SENKO's integrated Plug and Play IP Fan-Out kits benefit from up to 24 Fiber MPO. They allow quick and repeatable connectivity between the Fan-Out, main feeder and jumper leads. This enables maximum on-site flexibility and /or future expandability. These Fan-Out kits are particularly useful for networks with a range of site configurations, Multi Operator and/or Multi Technology applications.

(See page 23)



IP-Distribution Boxes

Weatherproof junction boxes



The SENKO harsh environment (IP) Distribution/ Demarcation boxes are a flexible range designed to be used either indoor or outdoor providing many years of reliable service. They interwork with the SENKO IP Connector and Adaptors and can be configured to cater for many combinations of fiber connectivity. On-site or factory pre-configured options are available.

They incorporate the SENKO IP range of connectors/adapters and can be configured to accommodate many types of fibre connectivity.



IP-68
Weather proof



Simple connection



Maximize your saving



Maximum Junction

FEATURES

- A wide range of sizes and configurations
- Fibre only or combined Power and Fibre variants
- Durable
- Plug and Play
- IP rated
- Light and easy to install
- Pole or wall mounted

TECHNICAL CHARACTERISTICS

Material	Polycarbonate
Operating Temperature	-40°C to +70°C
IP Rating	IP 68

CTJ-F Box

The IP-Distribution junction box provides flexible connectivity and demarcation for your harsh environment applications.

2 ASSEMBLY OPTIONS:
"Direct mate" and
"Feed Through"

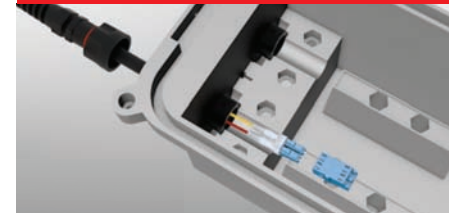

CTJ-BOX® Cell Tower Junction Box Hybrid

Shortest
installation
time, minimum
labor cost

The SENKO Cell Tower Junction Box (CTJ-Box) has been developed to meet customer demands in the evolving telecoms market.

FEATURES

- Up to 6 Fibre Outlet Ports (12 Fibers)
- Up to 6 x 2 Pole Power Outlets Ports
- Up to 6 x 2 Pole SPD (Surge Protection Device) Power
- M 40 Cable Glands (up to 1,25" cable diameter)
- M32 Cable Gland up to 5/8" cable diameter
- Isolation Switches
- Compact design
- Weather proof



Weather proof



Maximize your saving

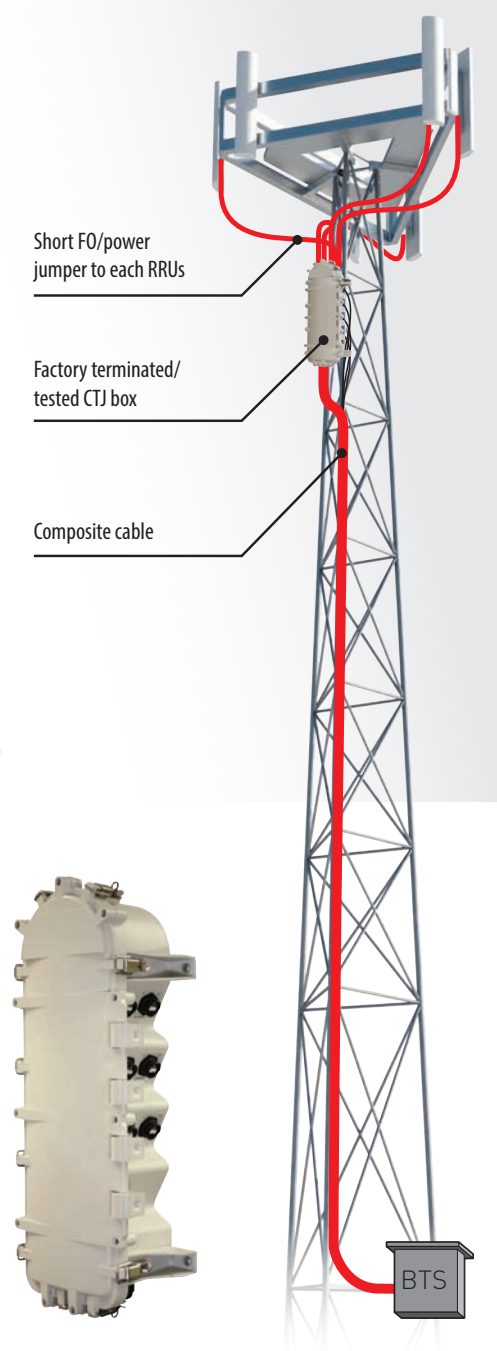

SPECIFICATIONS	DIMENSIONS (L X H X W)		WEIGHT	
	mm	Inches	Kg	lb
3 - Fiber Port Terminals (up to 6 fiber outputs total)	500x190x13	19.7x7.5x5.1	2.9 Unloaded	6.5 Unloaded
6 - Fiber Port Terminals (up to 12 fiber outputs total)	700x190x13	27.5x7.5x5.1	3.75 Unloaded	8.25 Unloaded

BOX	PORT	CLOSURE	ADAPTOR
CTJ-H CTJ Hybrid Box	03 3 Hybrid Port	S Screw Closure	1 Adaptor Loaded
		L Latch Closure	2 Without Adaptor
		SL Screw + Latch	C Custom

CTJ-H - 03 - SL - 1 Order Code Example



Plug & Play Fan-Out Fan-Out Assembly



The SENKO integrated Plug & Play assembly is our latest IP Fan-Out solution, that allows the use of a Pre-Terminated feeder cable fitted with the SENKO IP-MPO connector with up to 24 fibers. This provides a quick connection of the main feeder cable to the Pre-terminated fan-out. This ensures maximum configuration flexibility for complex inconsistent network rollout programmes and future upgrades.

SPECIFICATIONS

Mounting	Hose Clip / Cable Tie	IP Rating	IP-68
Number of Fibers	4 to 24 *	Tensile Rating	Fan-Out Side: 50 lbs (222N)
Suitable for Connector Types	IP-LC, IP-SC, IP-MPO		
Temperature Range	-40°C to +85°C		

* Note: According to Media Type

APPLICATIONS

- Telecoms
- Broadcast
- Commercial
- Domestic
- Education
- Medical
- Maritime
- Military
- Oil and Gas
- Transport
- Renewable Energy



Simple connection



Maximize your saving



Maximum Fan-Outs

FEATURES & BENEFITS

- Pre-Terminated Assembly
- Various Output configurations (IP-LC, IP-SC)
- True Plug and Play connectivity
- IP-68 rated
- Maximum flexibility and expandability
- Smallest footprint : 100x 40mm
- 4 - 24 fiber MPO

CONFIGURATIONS

Available in a range of configurations from 3 - 12 leads catering for 6 to 24 fibers in LC Duplex or 3 to 12 fibers in SC simplex.

HARSH ENVIRONMENT ACCESSORIES

Manage your connectivity with SENKO's specially designed Fan-Out brackets and mounting accessories. These brackets logically structure your Fan-Outs and include clear color-coded labelling. They provide fast and effective installation, ongoing maintenance and future expansion.



Fan out Distribution & Demarcation Bracket

APPLICATIONS

- Telecoms
- Broadcast
- Commercial
- Medical
- Maritime
- Military
- Oil and Gas
- Transport
- Renewable Energy



Top View



Bottom View



Bracket is designed to manage SENKO's IP-FO range
 see [page 16](#) and [page 23](#)

Complete your end to end connectivity path with SENKO's range of Fan-Out kits from Outside plant environment to indoor/in cabinet connection.



PSA (Pulling Sock Assembly) Pre-Termination Kit

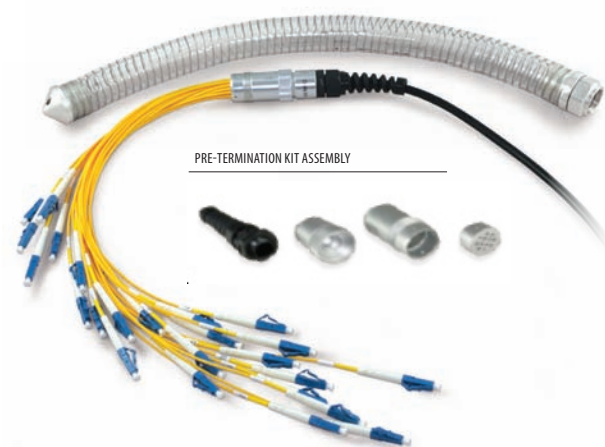

SPECIFICATIONS			
Mounting	Hose Clip/Cable Tie - U Slot panel mount	Feeder Cable OD Range	2 - 7mm
Number of Fibers	12 to 24 *	Temperature Range	-40°C to +85°C
Suitable for Connector Types	LC, SC, FC, ST, MU	Fan-out cable Retention	>15lbs (>66N)
Dimensions	65mm x 24mm (Excluding cable gland)	Feeder Cable Retention	100lbs (450N)

* Note: According to Media Type 2.0mm or 900µm

APPLICATIONS

- Telecom
- Datacenter
- Broadcast
- FTTX
- Enterprise
- Renewable Energy



Easy assembly



Maximize your saving



Maximum Fan-Outs According to Media Type

FEATURES & BENEFITS

- Metal Body Construction
- Easy assembly
- U-Slot Panel Mount
- Fan-Out Tubing size: 12 x 2.0mm, 24 x 2.0mm options
- Optional Pulling Sock
- IP-68 rated with pulling sock installed
- Outdoor/Indoor

Ruggedized Compact Fan-Out



SPECIFICATIONS

Mounting	Hose Clip / Cable Tie
Number of Fibers	12 to 24 (Note: According to Media Type 2.0mm or 900µm)
Suitable for Connector Types	LC, SC, FC, ST, MU
Dimensions	56mm x 15mm (Excluding cable gland)
Feeder Cable OD range	2 - 6mm
Temperature Range	-40°C to +85°C
Fan-out cable Retention	>15lbs (>66N)
Feeder Cable Retention	100lbs (450N)

APPLICATIONS

- Telecoms
- Broadcast
- Commercial
- Domestic
- Education
- Medical
- Maritime
- Military
- Oil and Gas
- Transport
- Renewable Energy



Indoor applications



Compact size



Maximum Fan-Outs According to Media Type

FEATURES & BENEFITS

- Light Weight, Snap-together Molded Construction
- Easy Assembly
- Compact Size
- High performance low loss
- Fan-Out Tubing size: 12 x 2.0mm, 6 x 3mm, 12 x 900µ & 24 x 900µ Options

The SENKO Indoor fan-out range offer a variety of different layout options for most indoor applications. They are cost effective, time saving solution that eliminates the need for splicing on-site.

Ruggedized Small Fan-Out Kit

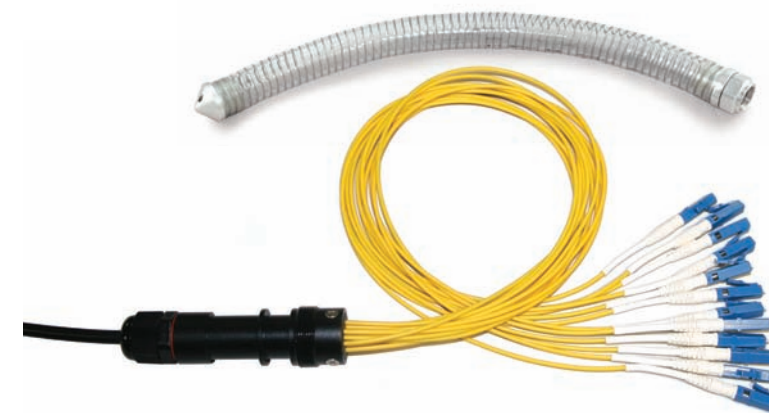

SPECIFICATIONS

Mounting	Hose Clip / Cable Tie	Feeder Cable OD Range	2 - 7mm
Number of Fibers	12 to 24 *	Temperature Range	-40°C to +85°C
Suitable for Connector Types	LC, SC, FC, ST, MU	Fan-out cable Retention	>15lbs (>66N)
Dimensions	65mm x 24mm (Excluding cable gland)	Feeder Cable Retention	100lbs (450N)

* Note: According to Media Type 2.0mm or 900µm

APPLICATIONS

- Telecom
- Datacenter
- Broadcast
- FTTX
- Enterprise
- Renewable Energy



Easy assembly



Maximize your saving



Maximum Fan-Outs According to Media Type

FEATURES & BENEFITS

- Metal Body Construction
- Easy assembly
- Small Size
- Fan-Out Tubing size: 12 x 2.0mm, 12 x 900µm, 24 x 900µm options
- Optional Pulling Sock
- IP-68 rated with Pulling sock installed
- Upgradable to IP-68 (without pulling sock)

What happens if the optical connector end face becomes contaminated?

Examples of common contaminants adhering to end face:

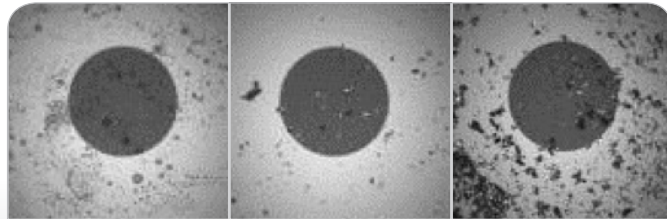

Hand Lotion **Fiber Residue** **Dirt and Dust**

Optical connector must have no contamination prior to mating.

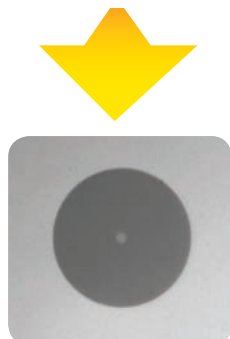
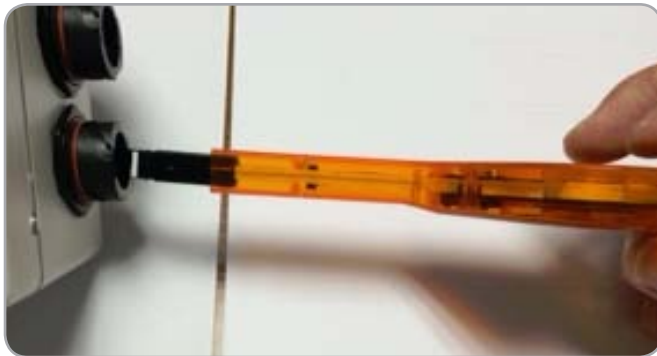

Clean connector

Troubles caused by connector end face contamination

Light is transmitted poorly or not at all

Light is reflected back to connection point*

**returning to the transmission point, causing equipment breakdown or bit errors.*

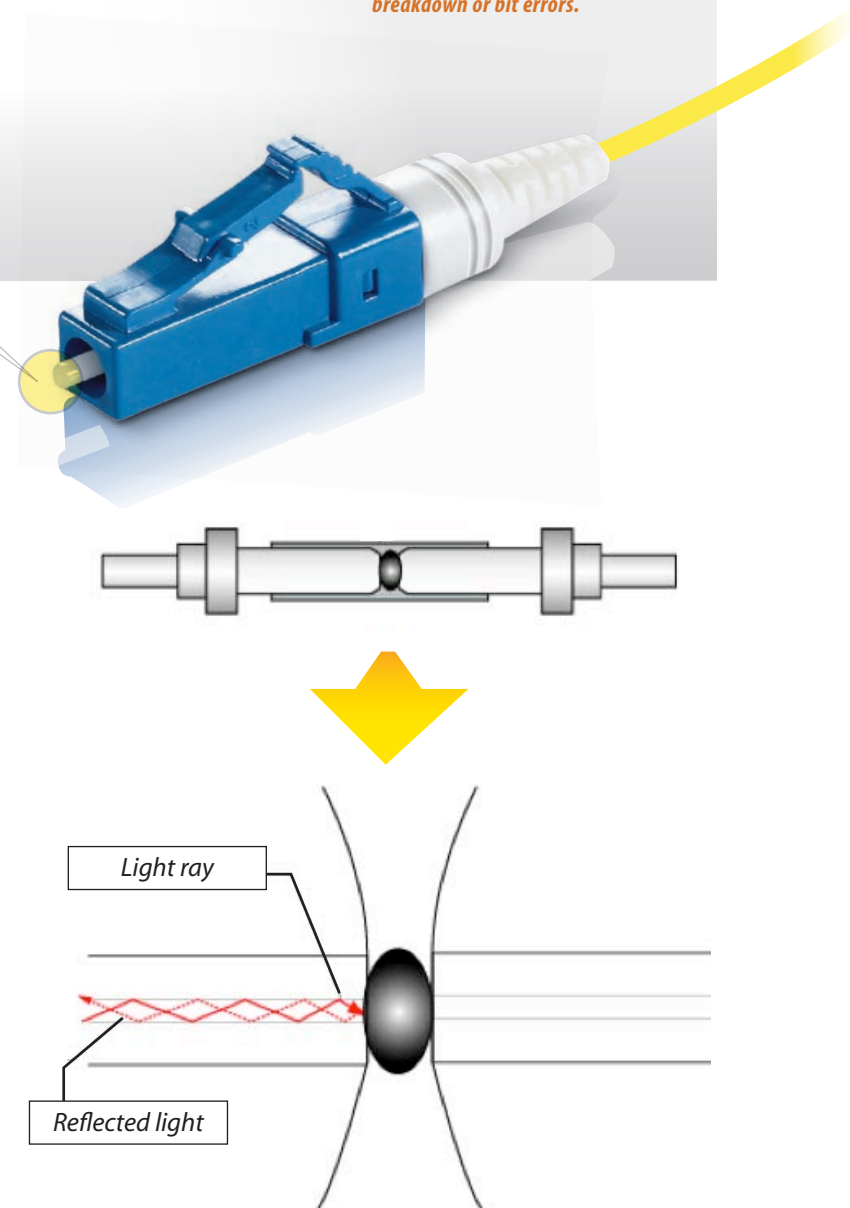

Smart Cleaner REPLACEMENT CARTRIDGE TYPE



Specifically designed to work with the LC/MU and SC/FC/ST/E-2000 connectors, this instrument cleans the ferrule end faces removing dust, oil, and other debris without nicking or scratching the end face. The SENKO Fiber Optic Cleaner for simplex connections is a dry cloth cleaner specially designed to clean single fiber connectors. The dust cap of the cleaner acts as an adapter for cleaning unmated connectors.

Smart Cleaner⁺

750+
CLEANINGS FOR EACH CARTRIDGE

ORDER CODE	DESCRIPTION
SCK-SS-125	Smart Cleaner 1.25 for LC, MU
SCK-SS-250	Smart Cleaner 2.50 for SC, FC, ST, E-2000

SPECIFICATIONS		
Product Name	Smart Cleaner 1.25	Smart Cleaner 2.50
Compatible Connectors	MU, LC PC and APC	SC, FC, ST, E-2000 PC and APC
Attachment Color	Brown	White

Smart Cleaner for MPO



Designed to work with MPO connectors, this instrument cleans the ferrule end faces removing dust, oil, and other debris without nicking or scratching the end face. The SENKO Smart Cleaner for MPO is a dry cloth cleaner with a push and click mechanism. Like other Smart Cleaners in the series the dust cap acts as an adaptor for cleaning unmated connectors.

Smart Cleaner⁺

600+
CLEANINGS FOR EACH CLEANER

ORDER CODE	DESCRIPTION
SCK-SS-MPO	Smart Cleaner MPO

SPECIFICATIONS	
Product Name	Smart Cleaner MPO
Compatible Connectors	MPO, MTP
Compatible End Face	Compatible with flat and 8 degree angled endface with or without guide pins

- Designed for all types of multifiber connectors
- Cleans jumper end face both male and female
- Compact size for easy hand-held operations
- Dry-clean without the use of harmful substances
- Cleaning micro fibers are densely stranded and debris free
- Constructed with anti-static material
- 600+ cleanings per unit
- Easy pushing motion engages connector and initiates cleaner

Wi-Fi STREAMING

Easily connects with Smartphones or Tablets

Smart Probe II

for Fiber Inspection



Images are captured digitally and streamed on the monitor of any compatible device

NEW PASS/FAIL Analytical software

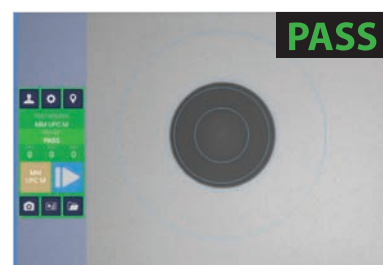

Free Download:



FEATURES

- Automated image transfer by email or Cloud storage facility
- PASS/FAIL based on IEC 61300-3-35 ed2 Standard
- Auto Centering

The app provides the best reliability and performance, confirmed through thousands of inspections and test set-ups to guarantee measurement repeatability and accuracy.

An embedded record of operational data including probe number, control and sensitivity settings, date and time confirmation and geographical location.

Fiber Checker



2.5 mm to 1.25 mm Adapter

Refraction of the 650nm red light caused by any breaks and or cracks in the fiber will glow red, thus giving an exact visual location of the fault in the fiber.

MPO 12 Smart Checker

VISIBLE FAULT LOCATOR



OVERVIEW

The MPO Visible light source is a useful tool designed for checking the Fiber ports in both MM and SM assemblies, or checking for defects in an MPO array. It emits a visible 650nm wavelength red laser light through fiber optic cables; if there are breaks or defects in the fiber then the light will refract, creating a bright glow around the faulty area. The Laser Diode output signal can be switched from all fibers at the same time or sequentially through each individual fiber in either Continuous Wave Mode or Flashing Mode to obtain different visual effects.

ORDER CODE	DESCRIPTION
AFT-G-FC	Fiber Checker
AFT-G-CAC	Fiber Checker 2.5mm to 1.25 mm Adapter

SPECIFICATIONS	
Laser Class	Class 2M
Wavelength	650 nm +/-10 nm@ 25
Spectral Width	< 10 nm
Output Power	>0.5 mW@ 25 into singlemode fiber
Mode	CW/ Pulse
Battery Type	AAA 1.5Vx2
Output Power Reliable	+/-0.2 mW
Transmitting Range	Visibility to 3 Km
Operating Temp.	0~ 50°C
Storage Temp.	0~ 70°C

FEATURES

- Robust & handy design
- Dust-free cap to protect LD
- Continuous / Pulse Mode options
- Emitting LD 650 nm visible red light
- Auto Power Control circuit design to provide a stable LD output power
- Low Voltage Battery warning signal in LED
- Universal 2.5 mm ferrule to 1.25 mm adaptor
- Compatible to SC / ST / FC / LC Connectors
- Visibility to 3 Km

ORDER CODE	DESCRIPTION
AFT-G-FC-MPO	MPO 12 Smart Checker

SPECIFICATIONS	
Cable Compatibility	4, 8 and 12 channel MPO Single Mode and Multi-Mode
Measurement	Fibre continuity by Visible Fault Location
Functions	Individual fibre channels selected using rotary switch and two digit LED display Select mode for all channels: continuous wave or pulsed
Light Source and Detector	Red laser on each output channel
Power	Internal lithium battery, re-chargeable via USB port Capacity: 1400mAh, min. Battery life: 5 hours
Laser Class	Class 2B
Wavelength	650 nm ± 10 nm @ 25 degC
Spectral Width	< 10 nm
Optical Output Power	> 0.4 mW @ 25 degC into 9 µm fiber
Light Emitting Range	> 3 km
Operating Temperature	0~ 50°C
Storage Temperature	0~ 70°C
Weight	0.65 kg
Dimensions	168mm (W), 128mm (D), 35mm (H)

Smart Probe™ for Fiber Inspection

The Smart Probe allows technicians to inspect the fiber endfaces, providing a high-definition image with a resolution up to 720px.



Images are captured digitally and streamed on the monitor of any Android Tablet or Smartphone.



Smart Cleaner™ for Fiber Cleaning

Introducing the new cleaners for MPO, SC, LC, LC optical connectors. Expanding its lineup of optical cleaners, Senko is able to respond to an even wider range of its customers needs.



XP Fit Plus™ Field Installable Connector

The XP Fit Plus is a pre-polished, pre-assembled connector that uses index matching gel. An internal mechanical grip, gently but effectively holds the fiber in place and can be installed in under 2 minutes. Without polishing or adhesives the XP Fit Plus makes reliable on site installations quick and easy, diminishing the need for epoxy curing and hand polishing at the work site.



www.senko.com

SENKO ADVANCED COMPONENTS, INC.

CALL 1-888-32-SENKO

America
USA EAST 1-888-32-SENKO
USA WEST 1-858-623-3300
TEXAS 1-972-661-9080
Sales-Americas@senko.com

South America
BRAZIL +55-21-3736-7065
Sales-Brazil@senko.com

Asia
HONG KONG +852-2121-0516
SHANGHAI +86-21-5830-4513
SHENZHEN +86-755-22699838
Sales-Asia@senko.com

Europe
UK +44 (0) 118 982 1600
ITALY +39 011 839 98 28
POLAND + 48 71 396 36 59
Sales-Europe@senko.com

Asia Pacific
AUSTRALIA +61 (0) 3 9755-7922
Sales-Asia-Pacific@senko.com
Middle East North Africa
DUBAI +971 4 8865160
Sales-MENA@senko.com

Japan
TOKYO +81 (0) 3 5825-0911
Sales-Japan@senko.com