

DUSTPROOF

Dust and Laser Protection

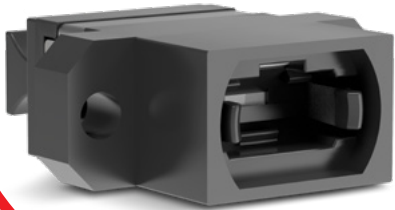

The MPO Plus dust shutter adapter has been developed to meet new requirements in data center, Telecom, and harsh environment plug & play solutions, offering quick one handed MPO connectivity with automated dust protection.

Combined with the SC or LC Inner Shutter adapter it will be possible to develop a completely dust proofed modular solutions that offer plug and play upgrade paths to 100G and beyond.

The MPO dust shutter adapter offers a reliable and convenient solution to protection from dust contamination for MPO ports, whether they are frequently patched or let redundant for months or years.

As active devices used in today's networking and telecommunication platforms increase in power, eye safety is becoming ever more important. With the increase of "lit" MPO trunking it has become important to prevent ocular damage to operators handling MPO connections as the potential for injury from multiple fibers is greater

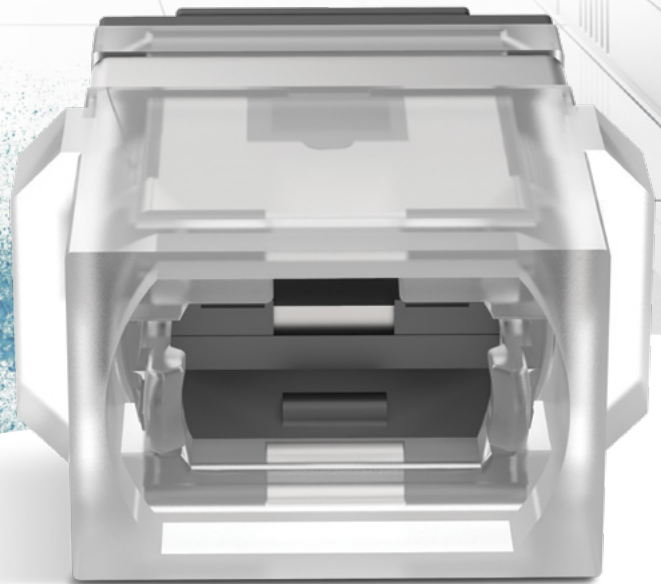

Dust Protection



Eye safety shutter

FEATURES

- 100% automatic shutter mechanism requiring no operator handling of the shutter door
- No dust cap required on shutter side
- Unique twin door shutter closes to prevent any ingress of contamination
- Standard MPO Foot print
- Suitable for harsh environment
- Front shuttered side is compliant with female MPO connectors only.

MPO+PLUS® DUST SHUTTER ADAPTER Step by Step

BENEFITS

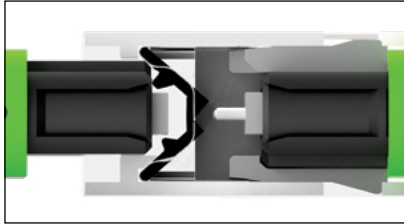

▶ 1 - Connector insertion

When the connector is inserted into the adapter it compresses the springs, opening the internal shutter.

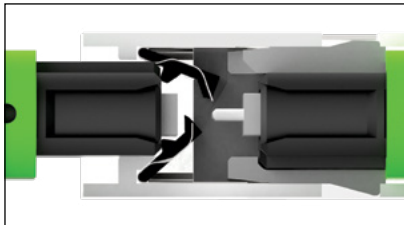

▶ 2 - Shutter opening

The internal shutter opens, and due to the special design of the shutter, it will **not touch the ferrule end face**.

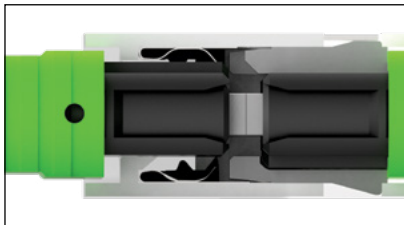

▶ 3 - Connector mated with adapter

The opening of the shutter allows for the ferrule to be inserted inside the adapter sleeve.

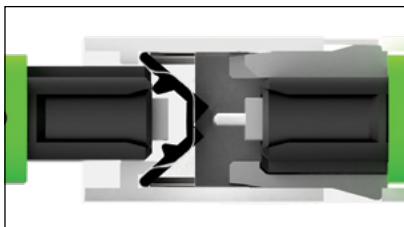

▶ 4 - Connector removal

As the connector is removed from the adapter, the shutter spring automatically returns the internal shutter to the closed position.

- Unique twin door shutter closes to prevent any ingress of contamination - **can be "installed and forgotten" at sites with poor dust control**
- 100% automatic shutter mechanism means **one handed connection**
- No dust cap required on shutter side - **reduced waste**
- Standard MPO Foot print - **fits all standard modules**
- Available in Black, Violet, Aqua, Lime, Green, and Gray colours - **easy identification of SM, OM3, OM4, OM5**
- Fully Meets GR-1435 Mechanical and Environmental requirements - **warranted reliability**
- Can be used in combination with the LC and SC Inner shutter adapter to create a fully dust protected plug and play solution - **Harsh Environment ready**
- Fully compliant with IEC dust testing standards
- Compatible with all Senko MPO+ connectors including HD

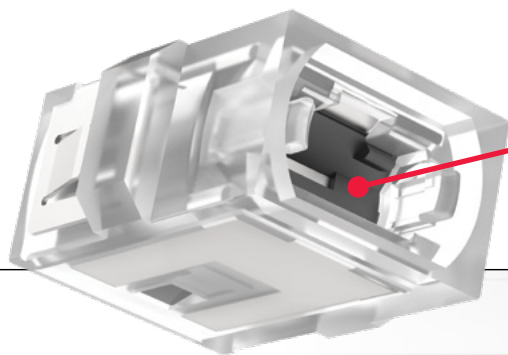

Automatic shutter mechanism

SENKO ADVANCED COMPONENTS, INC.

America
USA EAST 1-888-32-SENKO
USA WEST 1-858-623-3300
TEXAS 1-972-661-9080
Sales-Americas@senko.com

South America
BRAZIL +55-21-3736-7065
Sales-Brazil@senko.com

Asia
HONG KONG +852-2121-0516
SHANGHAI +86-21-5830-4513
SHENZHEN +86-755-2533-4893
Sales-Asia@senko.com

Europe
FRANCE +44 7939364565
Salesfrance@senko.com
GERMANY +49(0)15117683072
Sales-Germany@senko.com
ITALY +39 338 8919089
Sales-Italy@senko.com
POLAND +44 (0) 7796444488
Sales-Europe@senko.com

SPAIN & PORTUGAL +34 678042829
Sales-Iberia@senko.com
UK +44 (0) 1256 700880
Sales-UK@senko.com
OTHER +44(0) 1256 700880
Sales-Europe@senko.com

Asia Pacific
AUSTRALIA +61 (0) 3 9755-7922
Sales-Asia-Pacific@senko.com

Middle East North Africa
DUBAI +971 4 8865160
Sales-MENA@senko.com

Japan
TOKYO +81 (0) 3 5825-0911
Sales-Japan@senko.com

CALL 1-888-32-SENKO