

LC-HD CONNECTOR

Simplex, Duplex and Uniboot 913, 914 and 946 Series

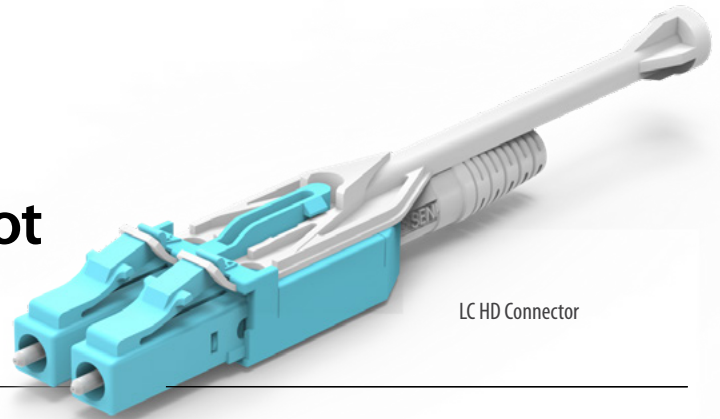

The SENKO LC-HD Connector is a high-density fiber optic connector designed for optimal performance and space efficiency in modern network infrastructures. It features a compact form factor that allows for increased port density, making it ideal for data centers and telecommunication networks. With its robust design and superior optical performance, the LC-HD Connector ensures reliable connectivity and efficient network operations.

The SENKO LC-HD connector's lever design utilizes a push-pull tab allowing for the connector to be inserted and disengaged easily from densely loaded panels without the need for special tools. Flexible pull tabs are also available with all offered in multiple lengths.

Because the SENKO LC-HD connector can be removed using a simple pull tab, it eliminates the need for finger access to the LC connector's latch mechanism, therefore LC adaptors can now be mounted much closer than spacing required in the past, achieving up to a 60% increase in panel density.

The low profile SENKO LC-HD, together with its pull tab, allows LC adaptors to be stacked with absolutely no vertical space, maximizing panel density and optimizing space utilization in network installations.

FEATURES

- High density design
- Compact form factor
- Pull-tab mechanism option
- Robust construction
- Fully compatible with IEC 61754-20

APPLICATIONS

- Data centers
- Telecommunications
- Enterprise networks
- Telecom infrastructure

KEY BENEFITS

- ✓ **Increased density**
- ✓ **Simplified installation and maintenance**
- ✓ **Robust reliability**
- ✓ **Increased versatility**
- ✓ **Not tools required**

Mechanical Data

	Value
Durability	<0.2dB typical change, 500 matings
Fiber Count	Simplex / duplex (1 or 2 Fiber)
Cable Suitability	900 μm to 3 mm*
Ferrule Material	Zirconia

* Custom sizes up to 5.5mm are available

Optical Data

	Singlemode				Multimode
	UPC		APC		MM
	Low Loss	Standard	Low Loss	Standard	Standard
Typical Insertion Loss (dB)*	0.05	0.08	0.07	0.10	0.10
Max. Insertion Loss (dB)*	0.15	0.20	0.15	0.25	0.20
Typical Return Loss (dB)*	≥55		≥65		≥25
Ferrule Diameter (μm)	125				127

* Based on master grade jumper to low loss random mating test

Environmental Data

	Value
Operating Temperature	-40°C to +75°C
RoHS Compliance	Yes
REACH Compliance	Yes
Humidity Resistance	95%

LC-HD CONNECTOR

913, 914 and 946 Series

Connector Drawing

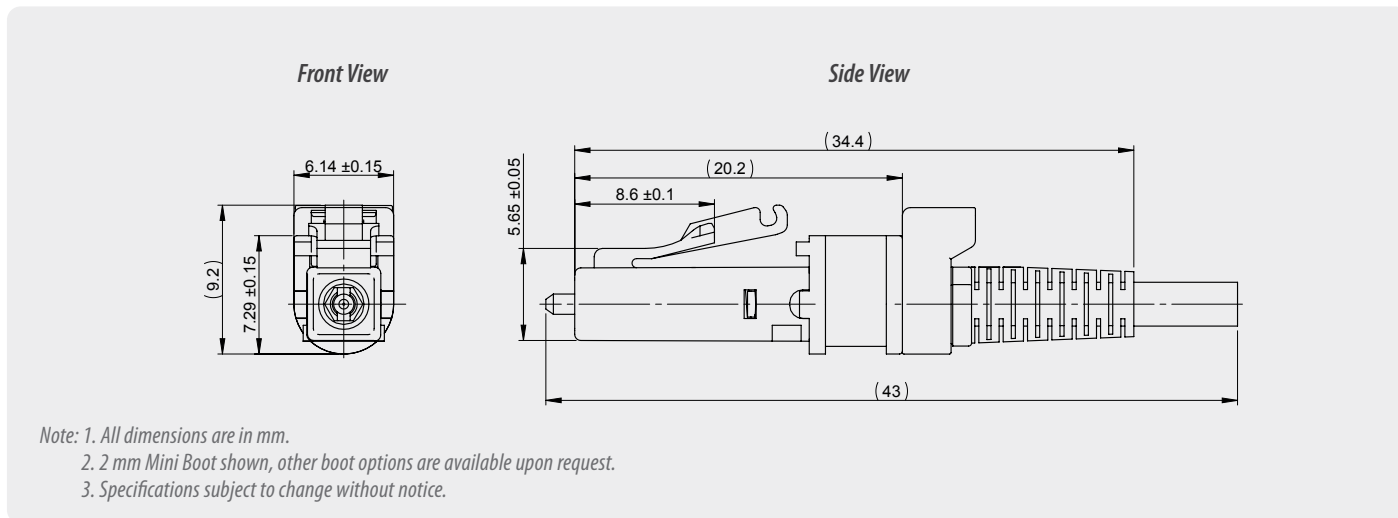

ORDERING

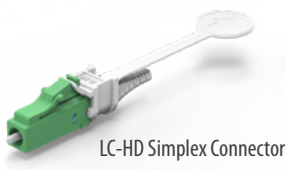

CONNECTOR	FERRULE TYPE	HOUSING	BOOT TYPE	BOOT COLOR
913 LC-HD Simplex	153 SM: Premium 125 μm	1 SM: Blue	B LC-HD MINI 900 μm	1 White
913P LC-HD Simplex	159 SM: Low Loss 125 μm	2 MM: Beige	C LC-HD MINI 2.0 mm	2 Blue
914 LC-HD Duplex	251 MM: 127 μm	3 SM APC: Green	U LC-HD 2.0 mm Duplex	3 Black
914P LC-HD Duplex		5 MM: OM3 Aqua	G LC-HD 1.2 mm Boot	4 Yellow
		6 MM OM4: Heather Violet		5 Red
				6 Green

913P - 153 - 1B1 ORDER CODE example

Note: 1. Pull tab must be purchased separately to complete the set
 2. 900 μm boot available for 913P and 914P series only

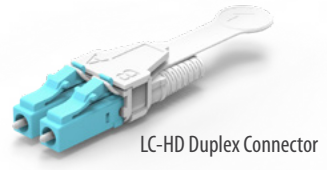

CONNECTOR	FERRULE TYPE	HOUSING	BOOT TYPE	BOOT COLOR
946P LC-HD Uniboot	153 SM: Premium 125 μm	1 SM: Blue	C MINI Boot 2.0 mm	1 White
	159 SM: Low Loss 125 μm	2 MM: Beige	D MINI Boot 3.0 mm	2 Blue
	251 MM: 127 μm	3 SM APC: Green		3 Black
		5 MM: OM3 Aqua		4 Yellow
		6 MM OM4: Heather Violet		5 Red
				6 Green

946P - 153 - 1C1 ORDER CODE example

Note: Pull tab must be purchased separately to complete the set

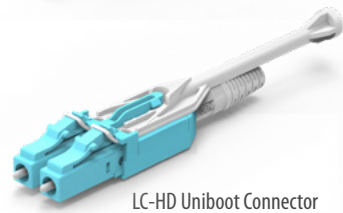

Pull-Tab Drawing

Side View Simplex Pull-Tab

WITH LC-HD SIMPLEX PUSH-PULL TAB AND SIMPLEX BOOT COLLAR (OPTIONAL)

Side View Pull-Tab

WITH PULL TAB (OPTIONAL)

Side View BTW Pull-Tab

WITH PUSH PULL TAB BTW (OPTIONAL)

Note: 1. All dimensions are in mm.
 2. 2 mm Mini Boot shown, other boot options are available upon request.
 3. Specifications subject to change without notice.

ORDERING



TYPE	
HDPP-S-BTW-W	LC-HD Push-Pull Tab Simplex

TYPE	CONNECTOR TYPE TO USE WITH	TAB LENGTH	TAB COLOR
HDPT	LC-HD Pull Tab	44 44 mm	W White
HDPP	LC-HD Push-Pull Tab	64 64 mm	
		84 84 mm	

HDPT - **S44** - **W** ORDER CODE example

Note: Push Pull Tab for LC-HD Uniboot only

Accessories - Production/Cleaning

Smart Cleaner™
Cassette
PN: SCK-CC-100

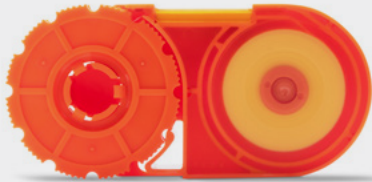

Smart Cleaner™
Mini 1.25 mm Clicker
PN: SCK-SS-M-C125
Refill PN: SCK-SS-CS-R



Smart Cleaner™
1.25 mm Clicker
PN: SCK-SS-CS
Refill PN: SCK-SS-CS-R



**1.25 mm NEOCLEAN
Cleaning Stick**
PN: CSK-01

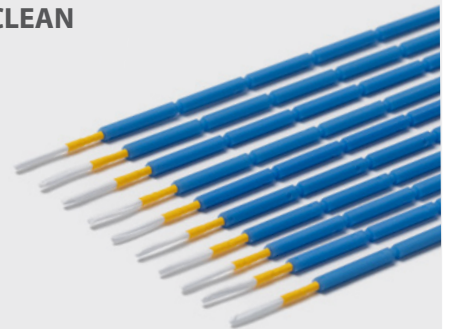

Accessories - Interferometry

SUMIX Manta W+ Inspection Scope
PN: SMX-Manta-W+



- Inspects 12 fiber in 2.6 seconds, 24 fiber in 4.5 seconds
- 0.5µm defect detection
- Inspection tips for MPO, CS, SN, LC available

SUMIX Max QM+ Inspection Scope
PN: MAX-Quantum



- Inspects 12 fiber in 2.6 seconds, 24 fiber in 4.5 seconds
- 0.5µm defect detection

SENKO[®]

Advanced Components

sales@senko.com
1-858-623-3300

senko.com/contact