

# SENKO®

Advanced Components

Your Source for  
Optical Interconnect Solutions

**Design • Test • Manufacture**

White Paper

JUNE 2016

## Fiber Optic Connector Hygiene

Bernard Lee

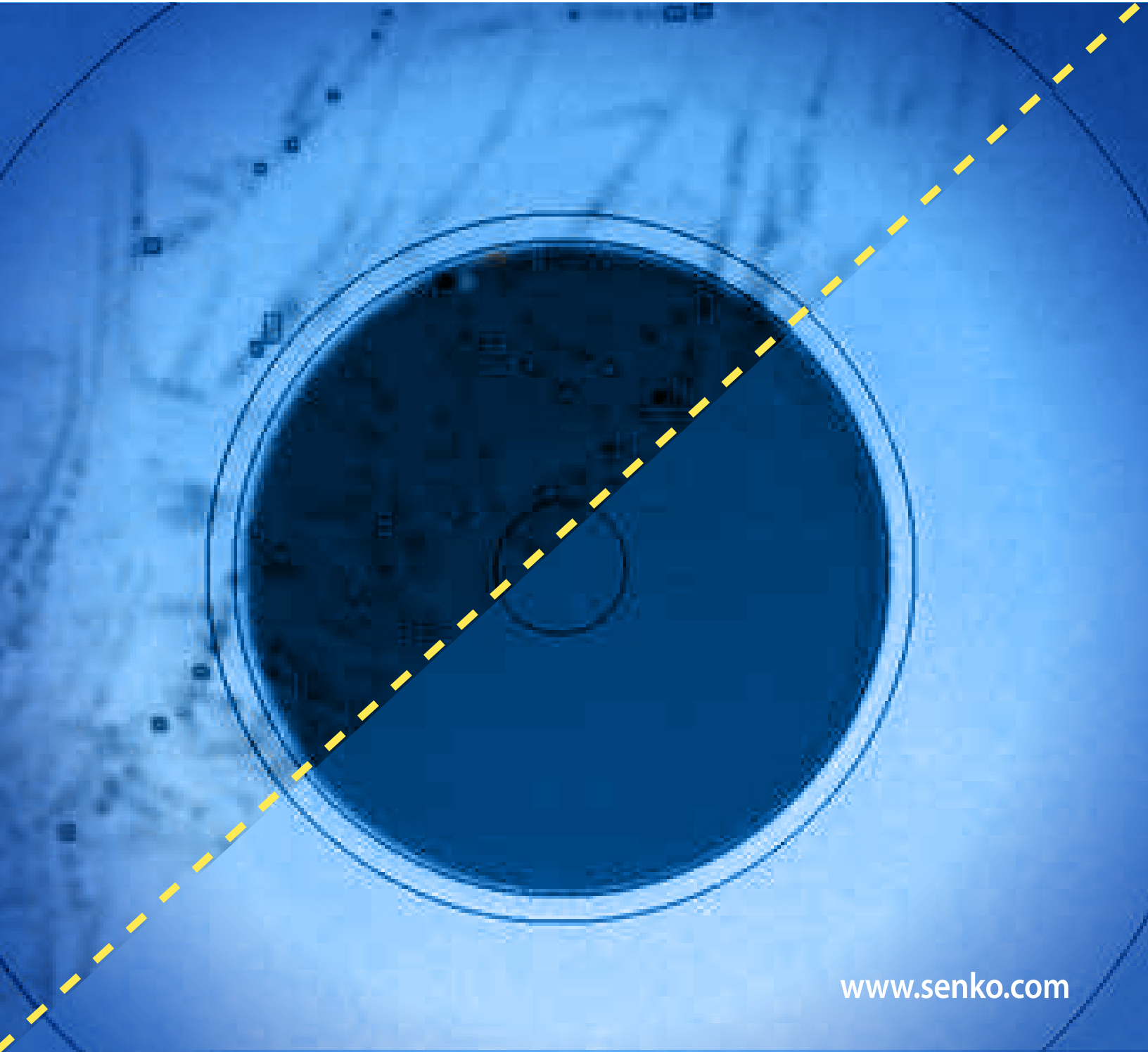

[www.senko.com](http://www.senko.com)

## SENKO ADVANCED COMPONENTS, INC.

### **America**

USA EAST 1-888-32-SENKO  
USA WEST 1-858-623-3300  
TEXAS 1-972-661-9080  
Sales-Americas@senko.com

### **South America**

BRAZIL +55-21-3736-7065  
Sales-Brazil@senko.com

### **Asia**

HONG KONG +852-2121-0516  
SHANGHAI +86-21-5830-4513  
SHENZHEN +86-755-2533-4893  
Sales-Asia@senko.com

### **Europe**

FRANCE +44 7939364565  
Salesfrance@senko.com  
GERMANY +49(0)15117683072  
Sales-Germany@senko.com  
ITALY +39 338 8919089  
Sales-Italy@senko.com  
POLAND +44 (0) 7796444488  
Sales-Europe@senko.com  
SPAIN & PORTUGAL +34 678042829  
Sales-Iberia@senko.com  
UK +44 (0) 1256 700880  
Sales-UK@senko.com  
OTHER +44(0) 1256 700880  
Sales-Europe@senko.com

### **Asia Pacific**

AUSTRALIA +61 (0) 3 9755-7922  
Sales-Asia-Pacific@senko.com

### **Middle East North Africa**

DUBAI +971 4 8865160  
Sales-MENA@senko.com

### **Japan**

TOKYO +81 (0) 3 5825-0911  
Sales-Japan@senko.com

[www.senko.com](http://www.senko.com)

# Fiber Optic Connector Hygiene

## Contents

|    |   |
|----|---|
| 4  | Executive Summary                         |
| 6  | Optical Connector Ferrule & Contamination |
| 7  | Inspection Standards                      |
| 9  | Inspection Tools                          |
| 10 | Cleaning Tools                            |
| 12 | Cleaning Challenges for MPO Connectors    |
| 13 | Cleaning Challenges for Transceivers      |
| 14 | Appendix                                  |
| 15 | Summary                                   |
| 15 | References                                |
| 15 | Biography                                 |

## Executive Summary

The dawn of the new millennium was a gloomy start for the fiber optic industry with the collapse of the 'Dot Com bubble' across the world. In 2001 alone, IT investment contracted sharply, with real IT investment falling nearly 11% and nominal investment plunging almost 17%, leaving an oversupply of IT equipment including fiber optic cables which had caused a sharp decrease of global fiber optic prices. Once only affordable to long haul and metro networks, the prices of fiber optics are now 'economical' enough to be adopted in the access network in order to deliver high speed broadband to the end users. Hence the birth of FTTH and FTTB. In the last 10 years, we have seen the number of broadband subscribers increase at a record pace with the number of Fiber-To-The-Home and Fiber-To-The-Building (FTTH/B) subscribers in Asia Pacific alone reaching 115 million by the end of 2014 with a total of 338 million homes passed. The top three countries with the highest FTTH/B homes passed are Japan (99%), South Korea (95%) and Singapore (95%). This is an increase of 35% from the previous year and it is expected to continue its growth rate and potentially overtake the number of xDSL based subscribers by the end of 2017. In addition, by the end of the decade, the estimated number of FTTH/B subscribers is 175 million subscribers.

In addition to the increase in FTTH/B connections, the number of mobile broadband connections have also increased with 3 billion subscribers and a 20% CAGR. By 2016, the number of smartphone subscriptions will surpass basic phones and the number of subscriptions is expected to double to 6.1 billion by 2020. It is also expected for 90% of the world's population to be covered by mobile broadband networks by 2020. Faced with high number of subscriptions, demand for improved communication services such as video calling and VoLTE, as well as higher definition video streaming, the mobile backhaul bandwidth requirement need to increase proportionally. In order to support the massive bandwidth demand, mobile backhaul links are forced to migrate from conventional wireless microwave based links running at sub 1Gbps to wired fiber optic based links running at speed of several tens of Gbps.

## Architecture Deployed

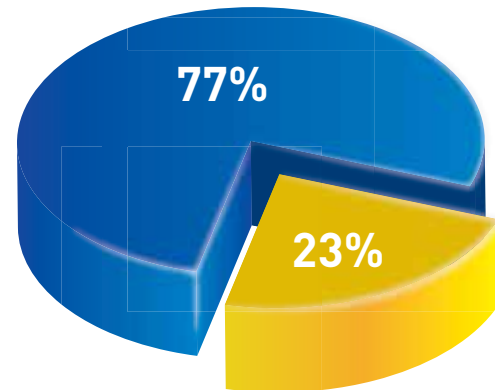

## Technology Deployed

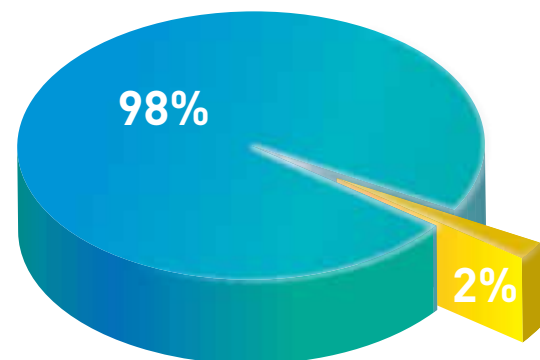

## Why fiber optics?

Well, one of the drivers of many network operators to deploy optical fiber has been, of course, its performance & reliability. Although the general maintenance requirement is greatly reduced with the use of fiber optics as compared to conventional copper, many network operators around the world are finding one simple component in an optical fiber network to be the common cause of most of their network failures. That component is the optical connector, dubbed the 'weakest link' of your network. Based on a study conducted by NTT Advanced Technology, 4 of the top 5 causes of network faults are connector related and the No.1 cause is contaminated connector end faces. The same problem is reported by major optical fiber network operators around the world with the lack of appreciation for fiber cleanliness accounting for 90% of all reported faults.

In the past, connector contamination in optical transport networks or data center fiber interconnect networks were less prevalent due to the controlled environment of exchanges or data centers by highly trained professionals. However, with the increasing deployment of optical fiber outside plant networks, optical connectors are widely used in outdoor enclosures such as roadside cabinets and pedestals as well as in customer premise termination points that do not have filters to reduce dust contamination or environment control systems to reduce humidity. Although connector contamination is common, it can be easily rectified. The main area of an optical connector that must be cleaned is the ferrule end face.



## Connector End Face contamination is the N°1 cause of network faults

1<sup>st</sup>

Contamination of the **connector** End Face

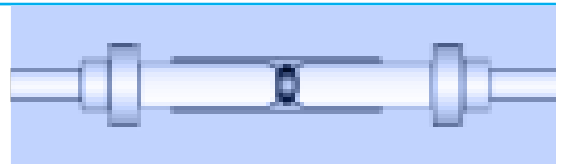

2<sup>nd</sup>

Poor polishing of the **ferrule**



3<sup>rd</sup>

Mistakes attaching **labels** to the cable



4<sup>th</sup>

Damage of the optical **connector**



5<sup>th</sup>

Damage of the **ferrule** End Face



## Optical Connector Ferrule & Contamination

The ferrule is the most essential part of the connector which holds and centers the optical fiber for connection with another section of a fiber network. As defined in IEC 61300-3-35, an optical connector end face is separated into three zones which are the Core (Zone A) where light travels, Cladding (Zone B) which is the outer section of the Core which reflects light back into the Core, and the Physical contact zone (Zone C & D) of 250µm where the ferrule and ferrule are mating.

The core of a single mode connector is only 9µm. A piece of dirt, speck of dust or oil smudge in the right position may cause high reflection, insertion loss and fiber damage. Connector cleanliness is critical in high power transmission systems such as DWDM systems or long haul transmission where Raman amplifiers are used, the optical signal transmission power may be up to 1W to 5W. In a single mode fiber transmission, such high power transmission may burn the contaminant and fuse the dirt with the silica material of the optical fiber, thus requiring the replacement of the connector.

The source of contamination is usually due to connector mishandling and a lack of understanding for optical hygiene. Some of the most common mistakes for contaminating optical connectors are:

- **Leaving a connector uncapped for even a short period of time where it will be prone to dust contamination.**
- **Touching the connector end face with fingers thus leaving skin oil or passing on dirt**
- **Using unsuitable cleaning methods or products such as toilet paper, water or even shirt sleeves**
- **Assuming that connectors which are protected by dust caps are clean or factory guarantee cleaned**
- **Not cleaning both connector end faces before making a connection.**

Clean connection

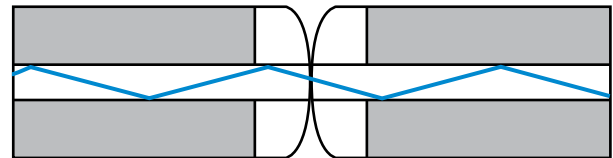

Dirty connection

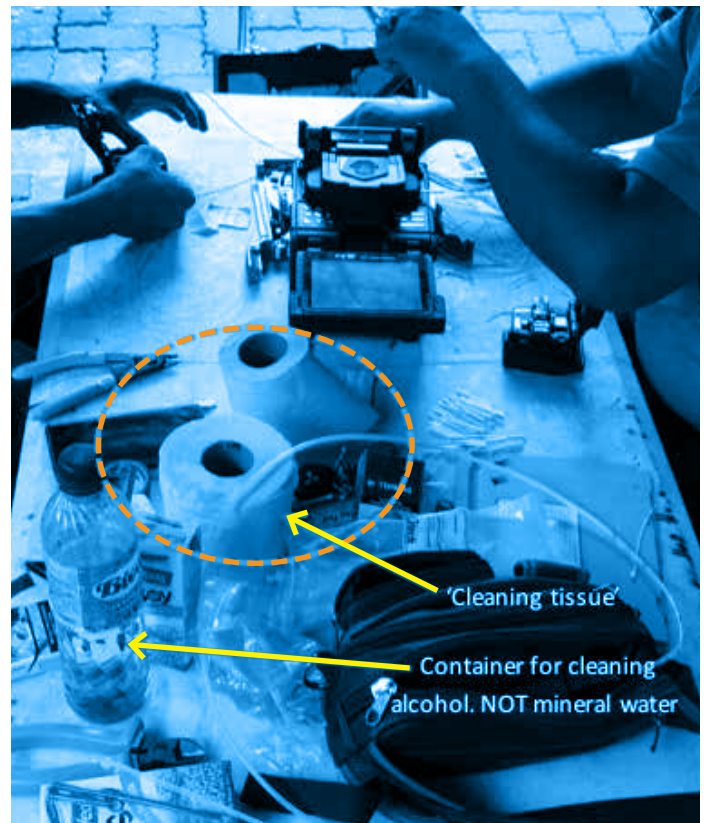
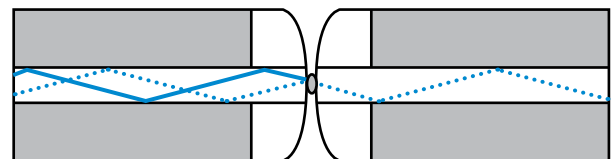

Image above: example of bad practice

## Inspection Standards

The 'IEC-61300-3-35: Fiber optic interconnecting devices and passive components - Basic test and measurement procedures - Part 3-35: Examinations and measurements - Visual inspection of fiber optic connectors and fiber-stub transceivers' sets the standards on measurement methods, procedure to assess the connector end face and determines the threshold for allowable surface defects such as scratches, pits and debris which may affect optical performance and it is the de facto standard for the fiber optics industry globally. According to the standards document, there are three inspection methods which are the:

- **Direct view optical microscopy**
- **Video microscopy**
- **Automated analysis microscopy**

The **Direct view optical microscopy** is essentially a microscope designed to view optical connector end faces. Although most of such microscopes have an optical filter to prevent eye damage from exposure to transmission lasers, many network operators do not approve its use due to health and safety reasons. Another disadvantage of this method is different microscopes need to be used for inspecting a connector or a connector terminated onto a bulkhead adapter.

Video microscopy uses an optical microscope which projects an image onto a display screen thus preventing any direct exposure to transmitting lasers. An example of a video microscopy is a **Fiber Inspection Probe (FIP)** with a display unit. Most FIPs available in the market have interchangeable tips to inspect bare connectors or when it is terminated onto a bulkhead adapter. There are also tips available for different connector types.

The **Automated analysis microscopy** is similar to the video microscopy but with an added feature which uses an algorithmic process to automatically analyze the connector hygiene based on a set criteria. This analysis provides a "Pass" or "Fail" result, thus removing any human assessment ambiguity.

### Fiber microscope



### Fiber Inspection Probe (FIP)



### Automated analysis microscopy



**CLEAN PASS**

**DIRTY FAIL**



There are two assessment procedures outlined in IEC-61300-3-35 for a single fiber ferrule such as an SC or LC connector and for a multi-fiber rectangular ferrule such as the MPO connector. The end face of the connectors are divided into measurement regions starting from the center of the core and moving outwards. The tables below outline the measurement regions:

### Measurement regions for single fiber connector

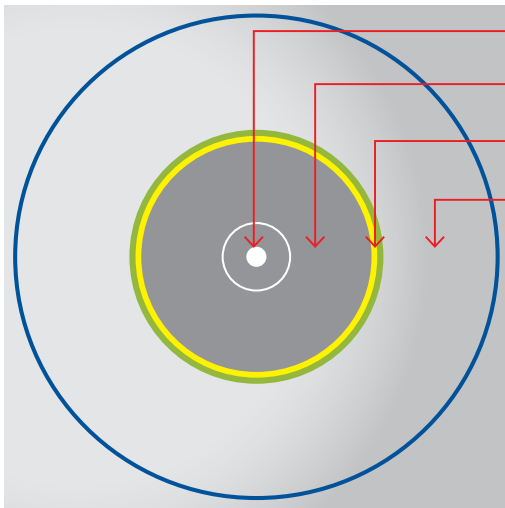

### Measurement region for multi-fiber rectangular connector

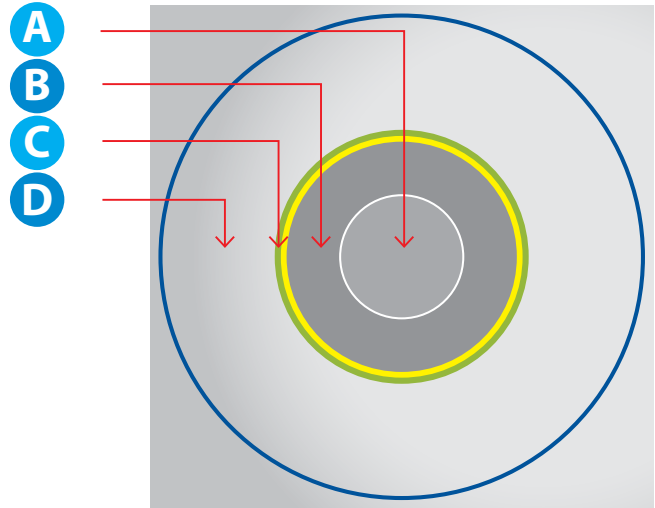

- A
- B
- C
- D

| Zone               | Diameter for single mode | Diameter for multimode |
|--------------------|--------------------------|------------------------|
| <b>A: Core</b>     | 0 μm to 25 μm            | 0 μm to 65 μm          |
| <b>B: Cladding</b> | 25 μm to 120 μm          | 65 μm to 120 μm        |
| <b>C: Adhesive</b> | 120 μm to 130 μm         | 120 μm to 130 μm       |
| <b>D: Contact</b>  | 130 μm to 250 μm         | 130 μm to 250 μm       |

| Zone               | Diameter for single mode | Diameter for multimode |
|--------------------|--------------------------|------------------------|
| <b>A: Core</b>     | 0 μm to 25 μm            | 0 μm to 65 μm          |
| <b>B: Cladding</b> | 25 μm to 115 μm          | 65 μm to 115 μm        |

Note 1: All data above assumes a 125 μm cladding diameter.  
 Note 2: Multimode core zone diameter is set at 65 μm to accommodate all common core sizes in a practical manner.  
 Note 3: A defect is defined as existing entirely within the inner-most zone which it touches.

Note 1: All data above assumes a 125 μm cladding diameter.  
 Note 2: Multimode core zone diameter is set at 65 μm to accommodate all common core sizes in a practical manner.  
 Note 3: A defect is defined as existing entirely within the inner-most zone which it touches.  
 Note 4: Criteria should be applied to all fibers in the array for functionality of any fibers in the array.

The IEC-61300-3-35 standard outlines the Pass/Fail threshold level for the visual requirements for the different connector types. These criteria are designed to guarantee a common level of connector condition for connector performance level measurement. Based on the zones of a connector, the standard outlines the allowable number of scratches as well as the size and number of defects.

**Please refer to Appendix for details (pg. 14)**



## Inspection Tools

The race to deploy broadband FTTx networks is resulting in a global fiber technician skill shortage. It is easy to train a technician to perform a connector cleanliness test but experience in operating and maintaining a fiber network is required to be able to make correct assessments. The use of automated techniques de-skill and reduce the risk of poor installation. An automatic Pass/Fail analysis function based on the IEC-61300-3-35. In addition, Geo tagging features together with cloud storage allow centralized review by fewer highly skilled technicians and confirmation that procedures were correctly carried out:

- **Prevent any error with a standardized and impartial assessment**
- **Increase productivity by speeding up the assessment process through set algorithm**
- **Avoid replacement of connectors with slight defects that do not adversely affect performance**
- **Ensuring excellent long term connectivity performance**
- **Confidence correct process has been carried out**

To cater for the massive adoption of FTTH services, the cost of setting up all the field technicians, is highly expensive especially with the various tools and equipment required to perform their tasks effectively. The common connector cleanliness inspection tool consists of an FIP and a monitor to view the connector end face. The monitor may be a standalone unit for the FIP, a different test equipment with a monitor such as an Optical Time Domain Reflectometer (OTDR) or a laptop. The high cost of these equipment becomes a barrier to entry for many fiber technicians or contracting companies and in many cases, proper inspection is not conducted. Hence, a low cost and high performance alternative is needed to cater for the market.

The cost effective SENKO Smart Probe is one of these cost effective alternative which allows relatively low skilled technicians to inspect the fiber end faces and stream the images to any laptop, tablet or smartphone. Many technicians already carry smartphones or tablets as part of their daily operations hence no additional display device is required and the SENKO Smart Probe connect to the smart devices via conventional Wi-Fi.

### Wi-Fi STREAMING

Easily connects with  
Smartphones or Tablets

## Smart Probe<sup>®</sup> for Fiber Inspection



Images are captured digitally  
and streamed on the monitor  
of any compatible device

## Cleaning Tools

Optical cleaning tools are specialized tools which are used to remove contaminants from optical connectors and bulk heads. There are two types of cleaning methods namely the dry cleaning and wet cleaning. The standard document, 'IEC 62627-01: Fibre optic interconnecting devices and passive components - Technical Report - Part 01: Fibre optic connector cleaning methods' describes a comprehensive cleaning methodology and is usually adopted as the industry's best practice.

Dry cleaning is the most common and fastest cleaning method which is used in connector manufacturing plants and in the field. The drawback of the dry method is the risk of potentially scratching the end face if there are any hard particles on the connector surface. In addition, some dry cleaners cause electro static charges on the

connector end face which attracts dust particles. The dry method usually cleans the majority of connectors, however, in more severe cases of contamination, the wet method is more effective.

The main advantage of the wet cleaning method is the active solvent used in the cleaner which acts as a solvent for oils, raises particles to prevent connector end face damage, removes moisture and is fast drying. The most common solvent used in the market is 99.9% isopropyl alcohol (IPA). The presence of a solvent prevents the buildup of electrostatic charge on the connector end face. However, the excessive use of solvents may cause the contaminants to be pushed to the side of the ferrule and slowly creep back into center after the connector has been inspected and terminated. To prevent such an occurrence, a final dry cleaning is performed after a wet clean.

The following table outlines the most common dry cleaning tools and the area of use:

|                                  |   |   |
|----------------------------------|---|---|
| <h3>Lint Free Swabs</h3>         |   | <p>Lint free swabs can be used to clean the internal barrel of a bulkhead adapter or the connector end face which is terminated in a bulkhead adapter.</p> <p>If sufficiently large, contaminant on the side of the internal barrel may cause misalignment of two connectors thus increasing the connector insertion loss.</p>  |
| <h3>Lint Free Wipes</h3>         |  | <p>Lint free wipes are not usually used to clean connector end face. The operation of wiping the connector end face with a lint free wipe requires delicate skill to avoid damaging the connector end face.</p>   |
| <h3>Cartridge Cleaners</h3>      |  | <p>A small window is opened to expose the cleaning cloth when the lever is pressed. This will also turn the cleaning cloth so that a clean cloth section is used for every clean. The connector end face is pressed and wiped against the cloth. For a more effective clean, specially treated cleaning cloth that prevents electrostatic charge buildup can be used.</p>   |
| <h3>Pen Cleaner</h3>             |  | <p>Pen cleaners have a reel of cleaning cloth that rotates at the tip of the cleaner when it is pressed against a connector in a bulk head adapter or directly onto a connector if a fitting is placed onto the tip. This instrument with a "push and click" mechanism cleans the ferrule end faces removing dust, oil and other debris without nicking or scratching the end face. There are mainly three types of pen cleaners suitable for 2.5mm, 1.25mm and MPO connectors.</p> |
| <h3>Adhesive Backed Cleaner</h3> |  | <p>Adhesive backed cleaners have a sticky tip with a soft backing at the top of the cleaner. This cleaner is pressed onto the end face of a bare connector or when terminated in a bulkhead adapter. The soft adhesive removed dust and other particles.</p>  |
| <h3>Compressed Air</h3>          |  | <p>Compressed air or air duster is used to blow air through the nozzle to get rid of dust on the connector end face. To maintain purity and pressure in the canned air, special material such as difluoroethane or trifluoroethane is used. It is advisable to select a material which has a lower Global Warming Potential (GWP) index.</p>  |

Wet cleaning is usually done by applying 99.9% isopropyl alcohol to any of the dry cleaner type in situations when contamination on connectors is unable to be cleared from dry cleaning alone. This usually occurs when contaminant on a connector end face is left uncleaned for a long period of time. Multiple wet cleaning may be required to fully clean a connector end face and must always be followed by a final dry clean to remove isopropyl alcohol residue.

There is currently no industry standard on the number of iterations one should attempt to clean the connector end face before disposing it but the common practice is generally 3 times. Nevertheless, an internal guideline should be set in order to avoid wasting time and resources trying to clean a contaminated/damaged connector. The diagram below summarizes the recommended cleaning procedure.

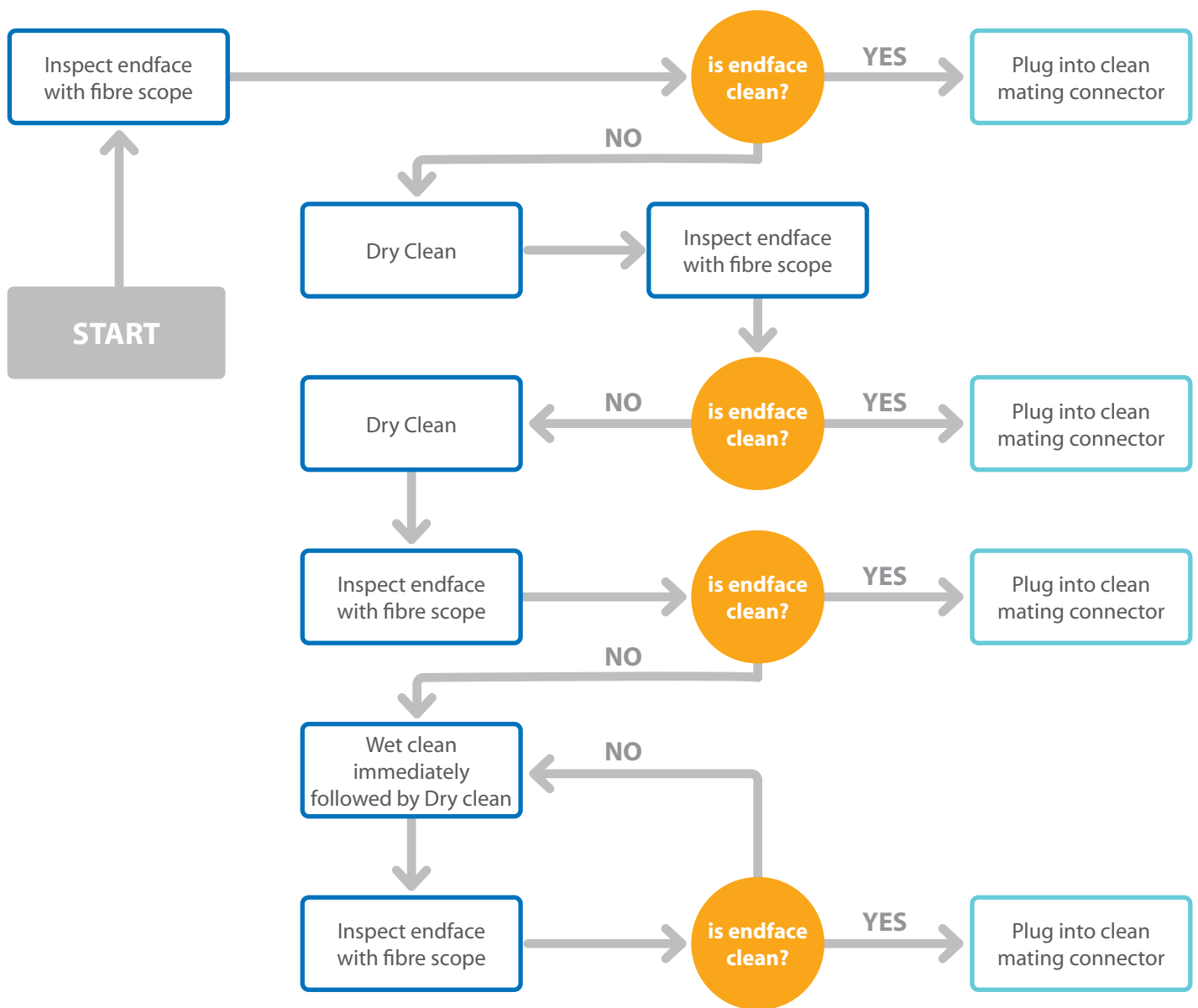

## Cleaning Challenges for MPO Connectors

Unlike single fiber connectors, the cleanliness of the total surface of a multi-fiber connector such as the MPO connector is also critical to making a proper connection. The array of fibers is presented on a flat surface which comes into contact when terminated. Any contaminant around the optical fibers and alignment pin prevents full contact of the two connectors. This creates an air space which reduces the connector loss performance. Conventional MPO cleaning tools such

as the pen cleaner clears contaminants around the optical fiber array. However the space around the alignment pins remains contaminated. A new type of MPO cleaning tool such as the SENKO Smart Cleaner Pad is able to effectively remove oil, dust and dirt particulate from pin to pin on the connector endface. An MPO connector is pushed onto the cleaner which sticks onto any contaminant, thus removing any particulate when the connector is removed.



### Conventional cleaner cleaning area

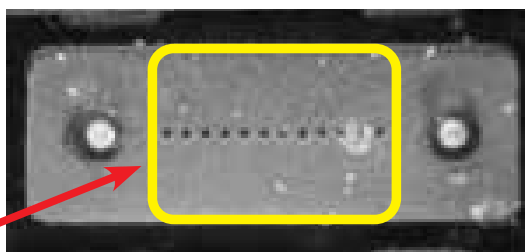

Particles around the pin area can remain which could cause "air gap."

### NEW "Pad" Cleaner Cleaning Zone will clean the full end face

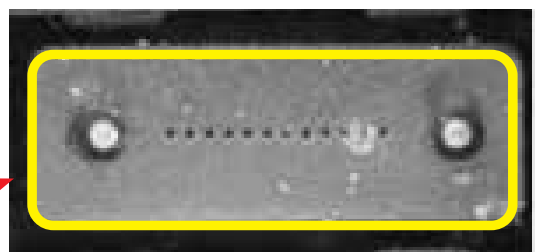

Full surface will be cleaned

## Cleaning Challenges for Transceivers

Unlike standard SC or LC connectors, transmitters and receivers such as those used in Small Form Factor Pluggable (SFP) are not as easy to clean and inspect. In some cases, the use of standard cleaning method may instead damage the connector. Most transmitters uses the Transmitter Optical Sub-Assembly (TOSA) and Receiver Optical Sub-Assembly (ROSA).

SFP transmitters such as the TOSA have either an SC or LC connector stub within the barrel. When viewed with a Fiber Inspection Probe (FIP), the connector within the TOSA will appear similar to a standard connector. As a result, the cleaning method of a TOSA SFP is identical to any standard SC or LC connector.

ROSA SFP receivers have an internal lens. When inspected with an FIP, the image of the SFP internal looks warped due to the internal design with the lens. To avoid damaging the SFP lens the standard cleaning methods cannot be used.

The following cleaning method is recommended:

- Use canned air to blow any dust and debris out of the connector
- Use a lint free swab of the correct size to clean. The main points when cleaning are:
  - The lint free swab must only be turned clockwise
  - The lint free swab must not be pushed too hard towards to lens
  - Solvents such as isopropyl alcohol must not be used
  - Adhesive Backed Cleaners may also be used as an alternative to lint free swab
- Inspect the SFP to ensure cleanliness. This requires experience to understand when the lens surface is the focal point when viewed through an FIP. Auto focus function on an FIP will not work
- Repeat cleaning process as necessary

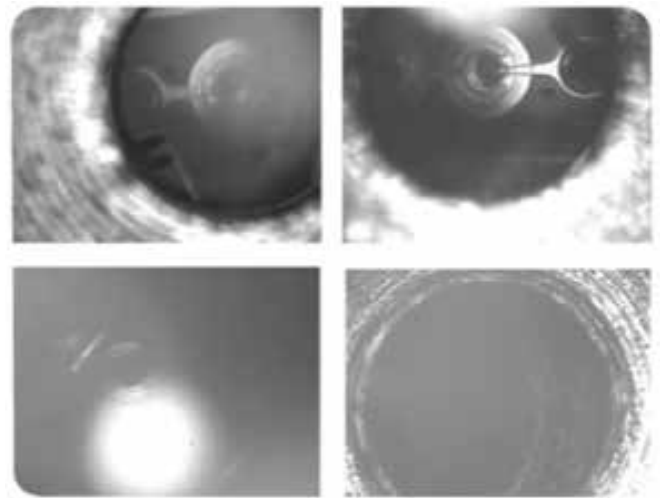
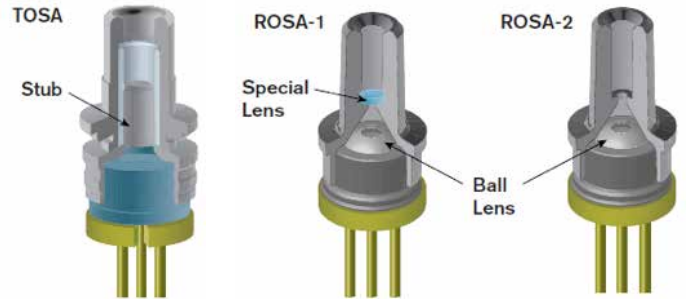

### Design



The absorption element accesses to fiber stub inside SFP transceiver port and removes dust and residue which cannot be cleaned by wipe type cleaners.

### Usage

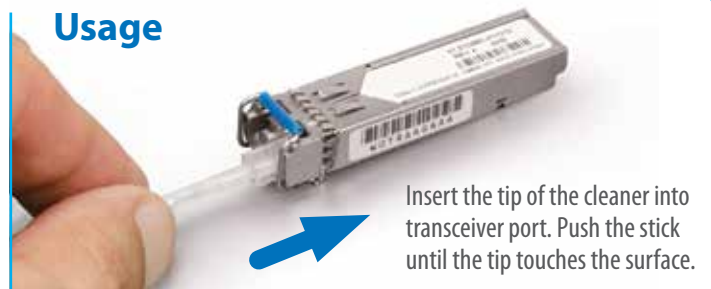

Insert the tip of the cleaner into transceiver port. Push the stick until the tip touches the surface.

### Before Cleaning

### After Cleaning

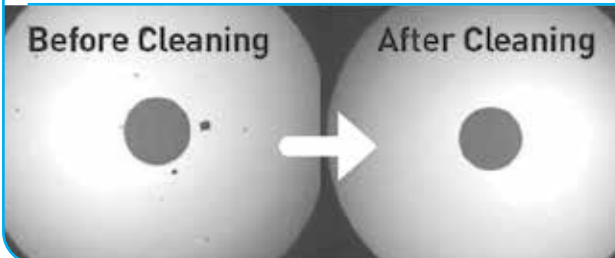

### FEATURES

- Designed to clean fiber stub inside SFP transceiver port
- Adhesive technology leaves no scratches or residue on fiber stub surface
- Anti-static materials to protect transceivers from ESD
- Can be used for the other LC connector compliant transceivers

## Appendix

Reference: IEC 61300-3-35:2009

### Visual requirements for PC polished connectors, single mode fibre, RL > 45 dB

| Zone               | Scratches  | Defects   |
|--------------------|--|---|
| <b>A: Core</b>     | None   | None  |
| <b>B: Cladding</b> | No limit $\leq 3 \mu\text{m}$ / None $> 3 \mu\text{m}$ | No limit $< 2 \mu\text{m}$ / 5 from $2 \mu\text{m}$ to $5 \mu\text{m}$ / None $> 5 \mu\text{m}$ |
| <b>C: Adhesive</b> | No limit   | No limit  |
| <b>D: Contact</b>  | No limit   | None $\geq 10 \mu\text{m}$  |



### Visual requirements for angle polished connectors (APC), single mode fibre

| Zone               | Scratches | Defects   |
|--------------------|-----------|---|
| <b>A: Core</b>     | $\leq 4$  | None  |
| <b>B: Cladding</b> | No limit  | No limit $< 2 \mu\text{m}$ / 5 from $2 \mu\text{m}$ to $5 \mu\text{m}$ / None $> 5 \mu\text{m}$ |
| <b>C: Adhesive</b> | No limit  | No limit  |
| <b>D: Contact</b>  | No limit  | None $\geq 10 \mu\text{m}$  |



### Visual requirements for PC polished connectors, single mode fibre, RL > 26 dB

| Zone               | Scratches   | Defects   |
|--------------------|---|---|
| <b>A: Core</b>     | $2 \leq 4 \mu\text{m}$ / None $> 3 \mu\text{m}$   | $2 \leq 4 \mu\text{m}$ / None $> 3 \mu\text{m}$   |
| <b>B: Cladding</b> | No limit $\leq 3 \mu\text{m}$ / $> 3 \mu\text{m}$ | No limit $< 2 \mu\text{m}$ / 5 from $2 \mu\text{m}$ to $5 \mu\text{m}$ / None $> 5 \mu\text{m}$ |
| <b>C: Adhesive</b> | No limit  | No limit  |
| <b>D: Contact</b>  | No limit  | None $\geq 10 \mu\text{m}$  |



### Visual requirements for PC polished connectors, multimode fibres

| Zone               | Scratches   | Defects   |
|--------------------|---|---|
| <b>A: Core</b>     | No limit $\leq 3 \mu\text{m}$ / $> 3 \mu\text{m}$ | $4 \leq 5 \mu\text{m}$ / None $> 5 \mu\text{m}$   |
| <b>B: Cladding</b> | No limit $\leq 5 \mu\text{m}$ / $> 5 \mu\text{m}$ | No limit $< 2 \mu\text{m}$ / 5 from $2 \mu\text{m}$ to $5 \mu\text{m}$ / None $> 5 \mu\text{m}$ |
| <b>C: Adhesive</b> | No limit  | No limit  |
| <b>D: Contact</b>  | No limit  | None $\geq 10 \mu\text{m}$  |



## Summary

With more optical fiber networks deployed and increasing bandwidth, the simple task of checking and inspecting connector hygiene must not be overlooked. As experienced by the majority of network operators, connector hygiene is the number one cause of network failure even up to today. It is very important that specialized optical connector cleaning tools are used in accordance with the proper procedure to ensure proper connector cleanliness and avoid network failure. Compliance to the standards provides a safeguard for the quality of installation and network performance.

## References

1. IEC 61300-3-35: Fiber optic interconnecting devices and passive components - Basic test and measurement procedures - Part 3-35: Examinations and measurements - Fiber optic connector end face visual and automated inspection.
2. IEC 62627-05: Investigation on impact of contamination and scratches on optical performance of single-mode (SM) and multimode (MM) connectors.
3. IEC 62627-01: Fibre optic interconnecting devices and passive components - Technical Report - Part 01: Fibre optic connector cleaning methods.
4. TIA-568C.3: Optical Fiber Cabling Components Standard
5. FTTH Council APAC: <http://www.ftthcouncilapac.org>

## Biography



Bernard HL Lee is currently the Regional Technology Director at SENKO Advanced Components. He started his career in optical communications when he was appointed as a Senior Research Office for the European Union IST project known as DAVID in 2000. In 2003, he joined Telekom Malaysia R&D where he has held various technical and management positions there including the Head of Photonic Network Research and also Head of Innovation and Communications. Bernard then joined the parent company, Telekom Malaysia (TM) in 2010 as the Assistant General Manager of the Group Business Strategy Division where he oversees the company's business direction. Bernard is also a member of the International Electrotechnical Commission (IEC), the Institute of Engineering and Technology (IET) and is also the Director of the Board of the Fiber-To-The-Home Council APAC.

[www.senko.com](http://www.senko.com)