

# CS<sup>®</sup> and SN<sup>®</sup> Connector

**SEPTEMBER 2021**  
*Rev. 01*

Issued by:  
Engineering  
Department

Created by:  
Andrei Vankov  
Emmanuel Kolczynski

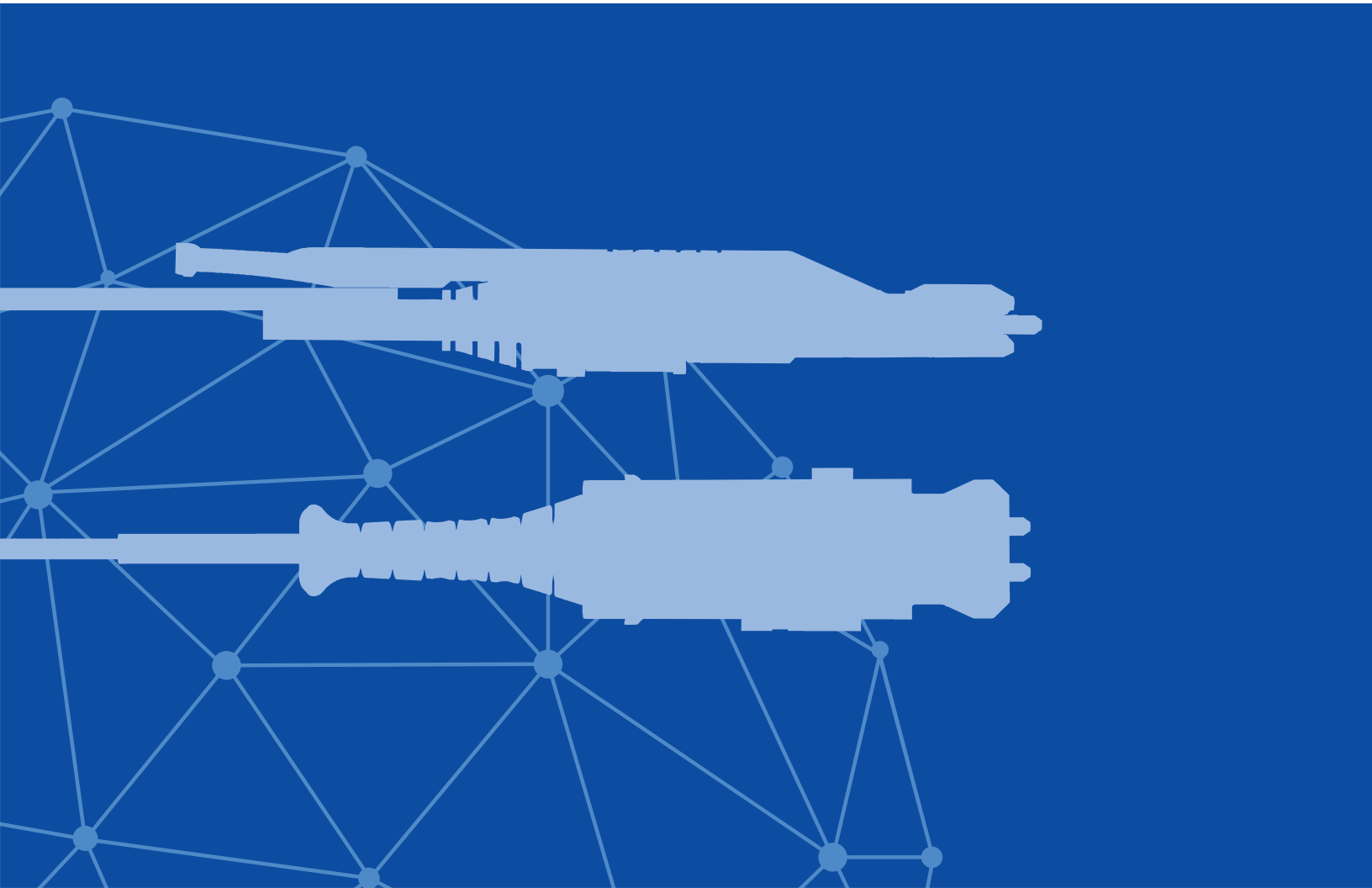

# CS<sup>®</sup> and SN<sup>®</sup> Connector

## Challenge

Data center growth has created challenges and opportunities for component and system vendors. The primary challenges include supporting increased bandwidth, density along with superior manageability without increasing the physical layer connectivity footprint of existing data centers.

Networking switch faceplate density is doubling with new product introductions from multiple vendors using the QSFP-DD as a transceiver interface. 128 single lanes (channels) ports or 32 quad lane ports have been the maximum network switch faceplate density in data center switches since 2012. Recently most networking switch ASIC vendors have been able to double the channel count on a single switch ASIC to 256 lanes. Several MSA's (QSFP-DD, OSFP, and SFP-DD) have been created with double-density transceivers to manage the increased bandwidth density while still maintaining a 1RU switch faceplate form factor. With these new double-density transceivers the fiber count has doubled from four lanes to having up to eight fiber pairs. Many of the transceiver implementations have split the eight lanes into two separate quad interfaces to maintain compatibility with the rest of the installed fiber and network switch infrastructure. When one of these new switches are deployed, the immediate need is to increase the number of fiber pair terminations in the same physical space as the current infrastructure in both the rack and the rest of the structured cabling infrastructure.

Looking at the optical interconnects in both enterprise and hyperscale data centers, the duplex LC and MPO connectors have been fundamental components in most of that infrastructure. Both the duplex LC and MPO are used extensively in structured cabling, and down to the individual transceiver interconnects. The emerging trends in the data center growth to increase bandwidth is to start migrating to double density pluggable optical modules that match network faceplate bandwidth with capable bandwidth delivered by the underlying network switch ASICs.

The MPO has been used for parallel optical engines that drive single wavelengths onto multiple fibers. Duplex fiber (CWDM or DWDM) solutions can take advantage of duplex LC connector.

A four-lane quad interface transceiver has a total of eight active fibers in a MPO-12. To support the double density transceivers with eight fiber pairs (16 fibers total), a different MPO would need to be used. Either an MPO-16 (single row of 16 fibers) or an MPO-24 (two rows of 12 fibers each) could be used. Increasing the fiber density on MPO connectors has led to other problems associated with the MPO connector. Keeping the end face of MPO clean has been one of the industry's more controversial topics. Most of the cleaners for MPO can clean only a limited area of the MPO connectors end face due to the existence of built in guide pins. Dust or particles which are left on the surface even after cleaning can cause the performance to worsen as the dust particle will cause a gap between mated fibers thus resulting in a loss of physical contact.

In addition to cleanliness challenges with parallel fiber connectors, getting consistent IL (Insertion Loss) between all fibers within the connector has been problematic. Repetitive mating cycles on a single connector can lead to different insertion losses between different fibers. MPO connectors require more operator interaction to get both a dust free connection that allows all fibers to conduct light, and an interconnect that has all fibers with acceptable insertion loss. If either problem exists, a MPO connector cleaning operation is required and repeated until insertion loss and fiber connectivity at the MPO interconnect meets the system design requirements. Adding more fibers in an MPO connector by either increasing the fiber density in a single row or adding a second row of fibers increases the effort of getting optical performance on all fibers for connectivity and insertion loss. Another method to address the best performance of MPO connectivity is to use MPO HighDura connectors. The advantages include better performance, less maintenance and obtaining optimal signal integrity.

LC connectors have been used for duplex (single pair) fiber attach with single or multiple wavelengths used on the single pair of fibers. The limitation of the duplex LC connector has been its physical size. The size of the existing duplex LC connector does not allow double density solutions with the existing form factors of today's QSFP form factor transceivers. Duplex LC connectors have been more robust in today's enterprise and hyperscale data center environments than the MPO connector. Duplex LC connectors have been developed with a zirconia ferrule and end face fiber that makes field cleaning simple and quick with traditional cleaning methods. The CS<sup>®</sup> and the SN<sup>®</sup> connectors like the duplex LC connector are constructed with a zirconia ferrule that is spring loaded to ensure that an adequate mating force is applied to get a reliable fiber connection with a consistent low insertion loss.

## New Solutions

There are two new solutions that have been designed to address the needs of the enterprise and hyperscale data center. These new connectors are called the CS<sup>®</sup> and the SN<sup>®</sup> connectors. Both connectors are leveraged from the parent duplex LC connector with 1.25mm O.D. Zirconia ferrules. The pitch of the CS<sup>®</sup> and SN<sup>®</sup> connectors have been changed to allow getting a 2-4x increase in fiber density at the transceiver.

## CS<sup>®</sup> Connector

The CS<sup>®</sup> connector was introduced as a replacement to current duplex LC connectors which are too big for newer generation transceiver interfaces and to increase the connector density in patch panels. The CS<sup>®</sup> connector is operated with a push-pull mechanism having two cylindrical, spring-loaded 1.25mm ferrules, within a single housing. The CS<sup>®</sup> connector's two ferrules are pitched at 3.8mm apart, which is the minimum possible spacing to meet today's TOSA and ROSA optics requirement. The CS<sup>®</sup> connector can be used with either 2mm or 3mm jacketed cable.

Compared to a standard duplex LC connector, the CS<sup>®</sup> connector has a 40% width reduction, which is a high value proposition especially in data centers where space is a premium. Furthermore, CS<sup>®</sup> has an advantage in height over a duplex LC connector. The duplex LC's latching lever design requires adequate vertical spacing between adapters to get physical access to the release lever. The CS<sup>®</sup> connector comes with an integrated push pull tab which allows the adapters to be more densely stacked vertically. CS<sup>®</sup> can more than double the density in the patch panel compared to duplex LC, with the features of narrower adapter width and denser vertical stacking of the CS<sup>®</sup> adapter. The CS<sup>®</sup> connector is currently undergoing standardization process in the Telecommunications Industry Association (TIA). The new connector will be standardized under a new Fiber Optic Connector Interface Standard (FOCIS) FOCIS-19 standard for a duplexed 2 ceramic ferrule connector.

The CS<sup>®</sup> connector is designed to be available in OM3, OM4, OM4+, and OM5 Multi-mode, as well as Single-mode(OS2) and Single-mode APC varieties. The connector design utilizes current industry processes for ferrule polishing, cleaning and visual qualification techniques. In addition, the connector also uses existing materials capable of extended service life qualifications. As the CS<sup>®</sup> connector is designed for application in data centers, telecoms, and enterprise industry, the connector is tested against standard performance qualifications. The main industry standard testing performed on the CS<sup>®</sup> connector has been GR-326 (Generic requirements for Single-mode optical connectors and jumper assemblies), IEC 61300-3-34 (Fiber optic interconnecting devices and passive components – Basic test and measurement procedures – Attenuation of random mated connectors - Grade B), and TIA 568 (Structured cabling system standards for commercial buildings, and between buildings in campus environments).

The CS<sup>®</sup> connector in addition to allowing a double density interconnect at the transceiver, it is also well suited to allow more than a doubling of fiber interconnect density within the structured cabling infrastructure space.

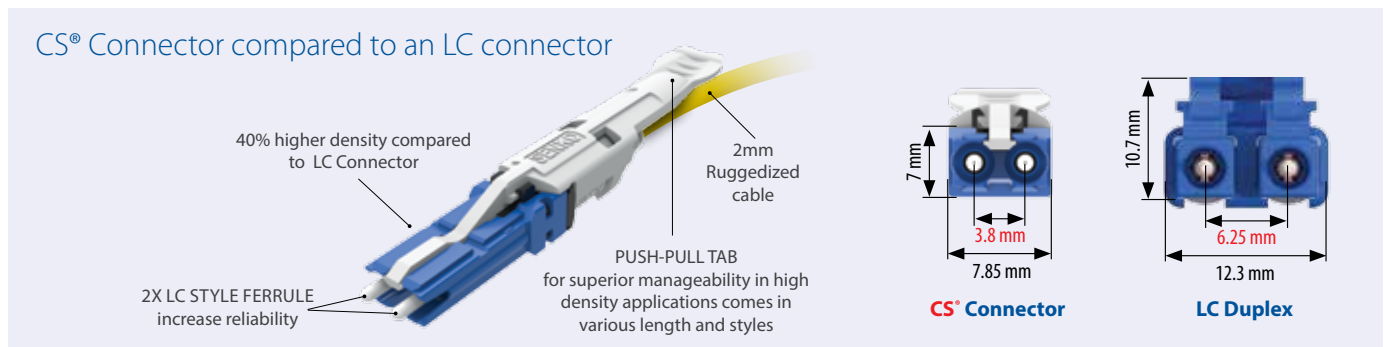

## SN<sup>®</sup> Connector

SN<sup>®</sup> connector is a new duplex optical fiber connector designed for Data Center 400G optimization. The SN<sup>®</sup> connector was designed to provide individual and independent duplex fiber breakout at a quad style transceiver (QSFP, QSFP-DD, OSFP) as a more efficient, increased reliability, and a lower cost alternative than the MPO connector. SN<sup>®</sup> has two (2) LC style 1.25mm O.D. Zirconia ferrules in a single housing, pitched 3.1mm apart vs 6.25mm in a duplex LC connector. Each of the SN<sup>®</sup> connector ferrules can be individually prepared, polished, and tested. This allows the manufacturer to easily control each fiber connection of the connectors. In addition, the use of a widely deployed 1.25mm ferrule allows for a simpler manufacturing process with an already streamlined manufacturing process. In comparison, MPO connectors are manufactured with all 12 fibers terminated into a single MT ferrule. The preparation, polishing, and testing are done for all 12 fibers simultaneously which can result in varying performances of each of the fiber connection. Since SN<sup>®</sup> uses the same zirconia ferrules as on the duplex LC, the entire end face can be easily cleaned by traditional cleaning methods. The SN<sup>®</sup> connector supports up to 1.6mm jacketed cable.

Another valuable feature of the SN<sup>®</sup> like CS<sup>®</sup> and LC connectors is the ability to support polarity changes that can be easily made in the field. This is something that is not achievable with MPO connectors for SM. MPO connectors for SM are angle-polished, angled top to bottom where the connector key is on top side. Due to this, SM MPO connectors cannot be flipped to change the polarity. Care must be exercised in planning MPO cabling infrastructure to ensure that the correct polarity of Tx and Rx and lane order are preserved through the cabling environment with the proper choice of MPO connector options. At times an additional MPO connector pair needs to be added into the link to ensure that proper polarity is preserved.

The design of the SN<sup>®</sup> connector allows users to have four individual connectors with eight fibers in total, within a single QSFP, QSFP-DD and OSFP transceiver interface. The SN<sup>®</sup> connector can be used for fiber applications such as PSM4, SR4, DR4, DR4+ and SR4.2 modules at the **transceiver where MPO is commonly used now**.

SN<sup>®</sup> is a push-pull style connector which allows for high density layout. Even though SN<sup>®</sup> allows up to 4 times higher density compared to duplex LC connector, the required quality, optical, and mechanical performance can be maintained.

SN<sup>®</sup> has some advantages compared to MPO

- **Easy break out/simple network structure**
- **Easy cleaning/maintenance of the ferrule end face**
- **Proven stable optical performance**

Today's MPO based transceivers with parallel links are used for communications links up to 500m. This is a

typical usage for leaf-spine or leaf to top-of-the rack switches network in Data Centers. To implement a mesh fabric network, signals coming out from one transceiver are split and directed to different switches. This will require a single MPO connector to be fanned-out to four (4) duplex LC connectors into a cross connect patch panel (or breakout box) that is connected to another duplex LC connector which is then fan-into a single MPO connector at the far end transceiver. This method requires the use of fan-out cables, jumpers, and cassette modules which take up rack space, and increases link optical attenuation. The additional connectors also become potential points of failure due to poor connector hygiene practices. This increases the deployment cost, and complexity with the use of more components in the network. Some of these components, such as the MPO-duplex LC fan-out cables, must be custom made for each application with different staggered lengths, thus increasing the logistical complexity.

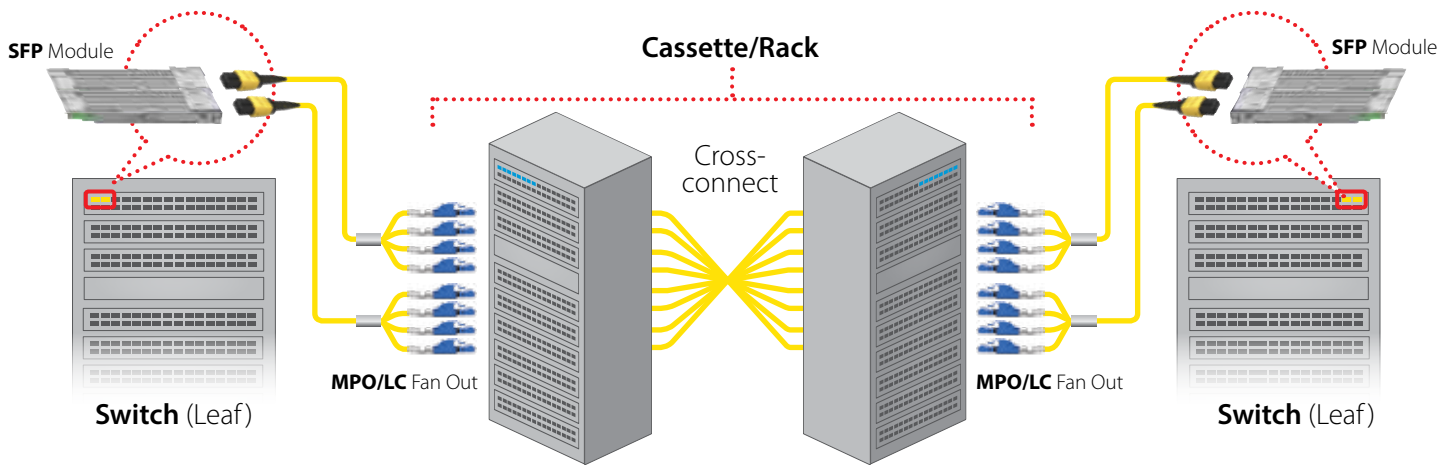

The SN® connector can simplify and reduce the overall cost of this structure, as SN® based transceivers are already broken out by having four (4) individual SN® connectors at the transceiver interface. To make a mesh fabric cross connection, it only requires SN® to SN® jumpers that can be connected point to point at the transceiver.

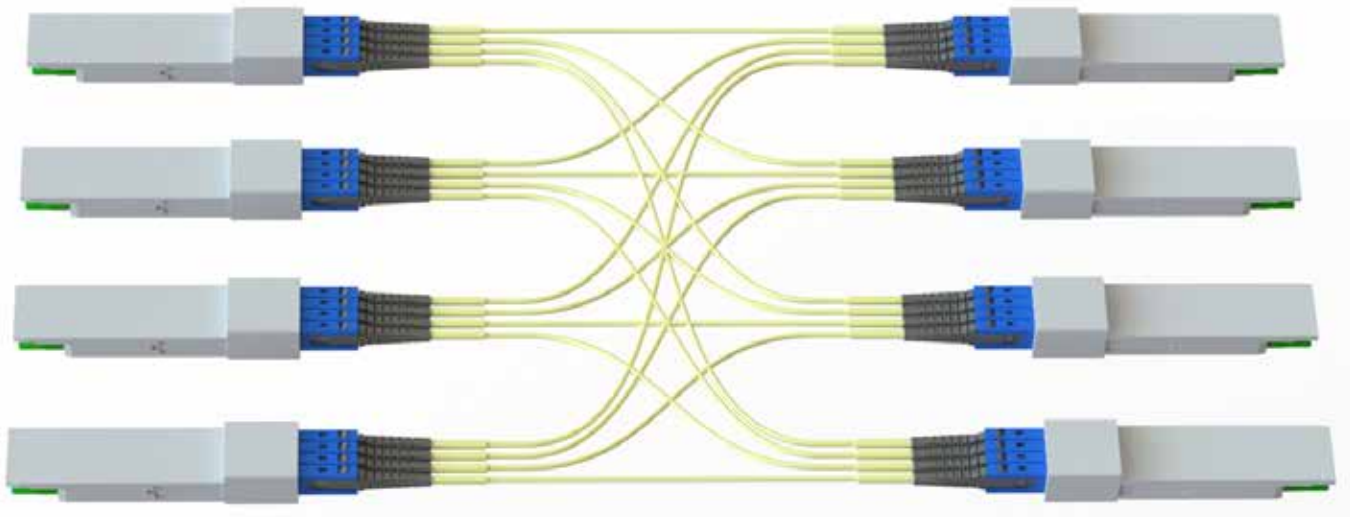

## Application solutions for CS® and SN® Connectivity

The enterprise and hyperscale data centers physical infrastructure structured cabling plant have not changed for many years with the use of duplex LC and MPO connectors. The recent requirements to increase the networking bandwidth in both the enterprise and hyperscale data centers provides additional advantages and benefits with the deployment of the CS® or SN® connectors.

Both the CS® and SN® connectors allow for increased density of interconnects over duplex LC in the rack and structured cabling infrastructure. The CS® and SN® also meet the needs of providing increased patch panel break out capabilities with new network switch densities within a 1RU form factor.

The CS® connector provides multiple physical layer cabling schemes such as point to point and central network point of administration (CPNA) through CS®/CS® and CS®/MPO trunk cables, CS®/CS and CS®/LC Jumpers. The CS® connector solid body structure provides superior mechanical strength as compared to an LC connector. This ruggedized construction is well suited for both outside plant as well as inside data center applications. The CS® exceeds the GR-326 requirements.

### Example of Enterprise ribbon array Fiber Trunk Cable Data Center Layout

In this application all the patch panels in the infrastructure are CS/MPO instead of LC with the trunk cables being MPO/MPO all the patch panel cross connect jumpers in the main area of administration are CS/CS. The jumpers to the end devices from the Zone cabinets are hybrid CS/LC. The two arrays to the mainframe and directors/switches are MPO/LC

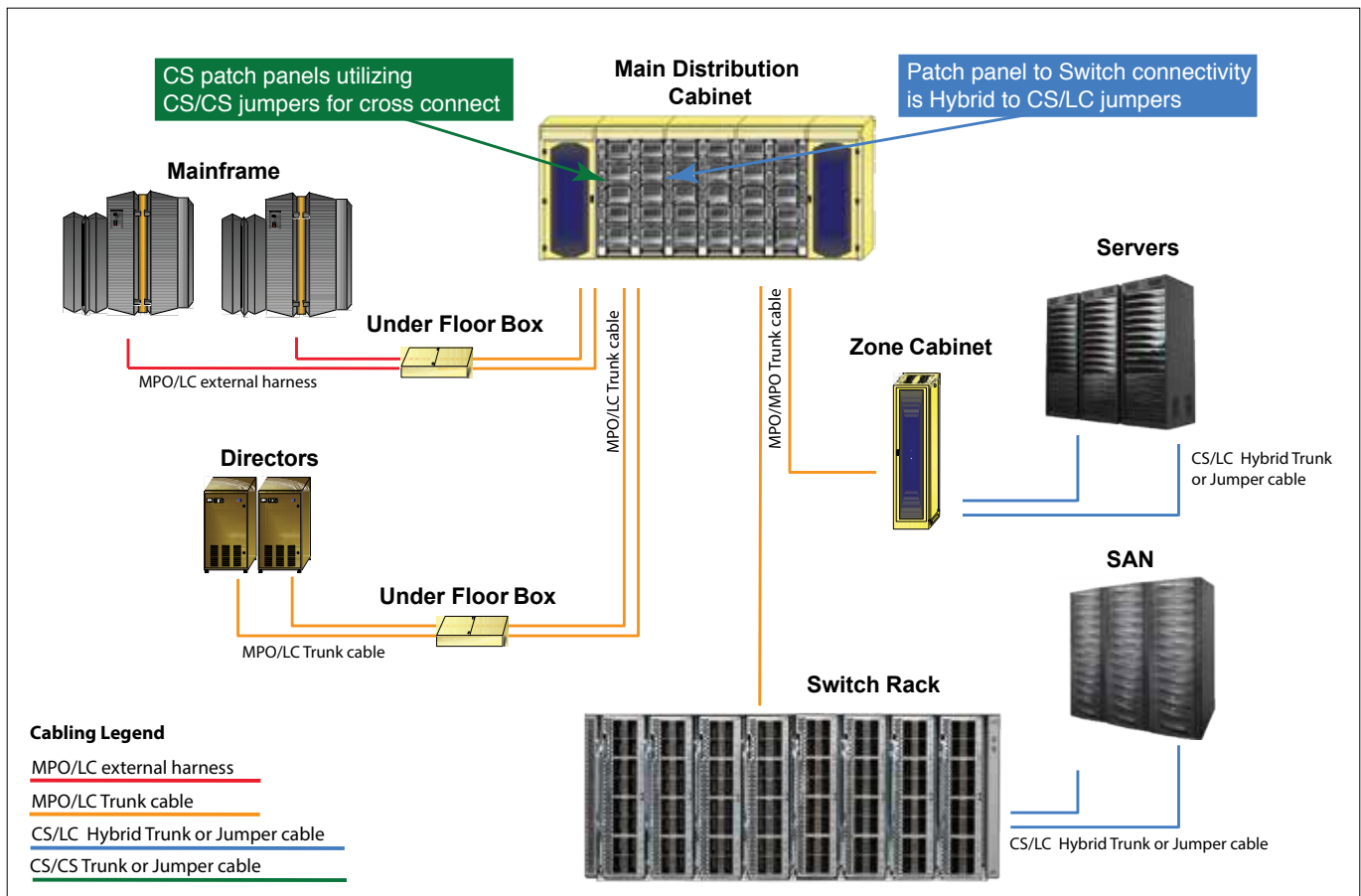

## Example of Enterprise Trunk Cable Data Center Layout

In this application all the patch panels in the infrastructure are CS instead of LC with the trunk cables now being CS/CS and all the patch panel cross connect jumpers are CS/CS. The jumpers to the switch in the main area of administration as well as the servers and end device jumpers are hybrid CS/LC

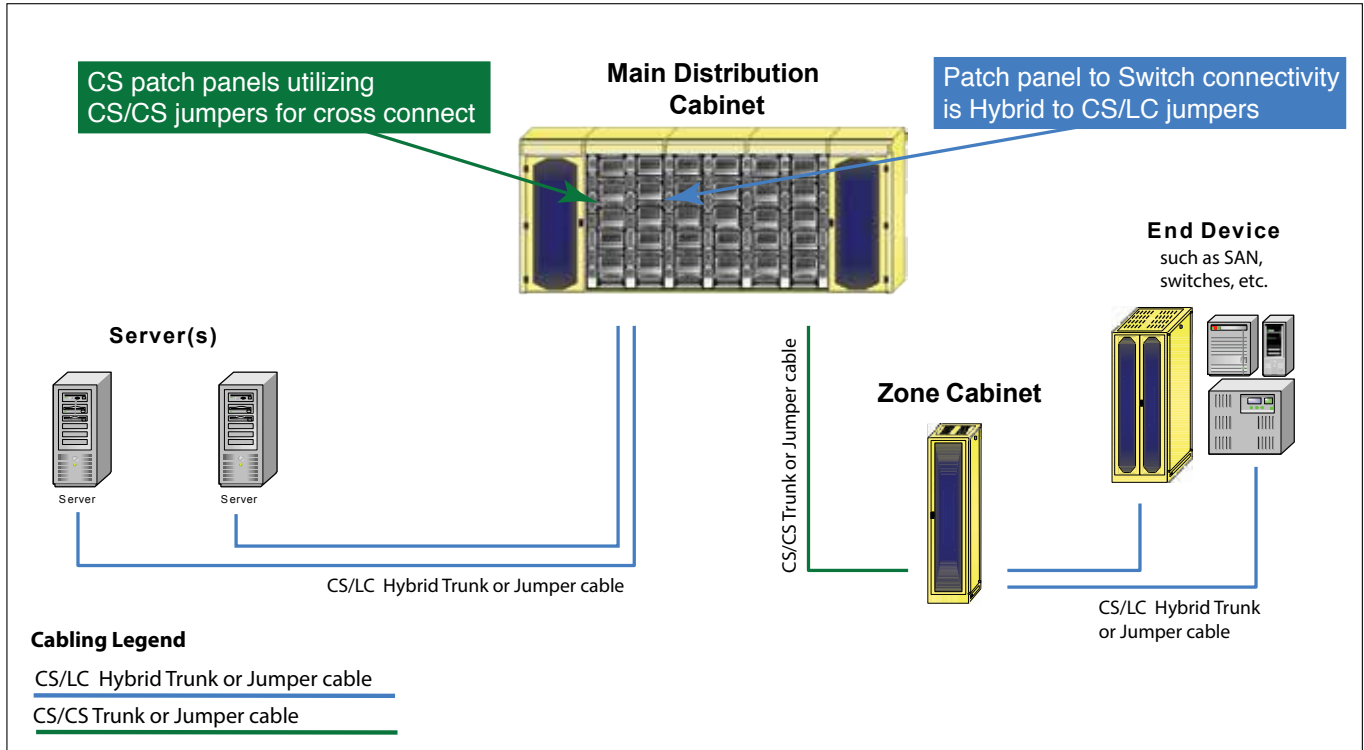

### CS® CONNECTOR

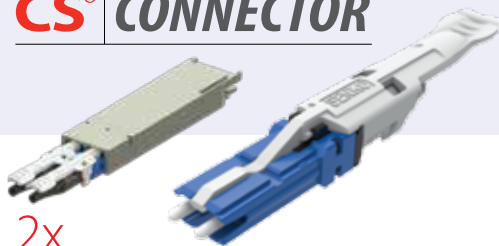

2x  
in QSFP Footprint

- Designed for 2x breakout
- Total 4 Fibers (2Fx2)

### SN® CONNECTOR

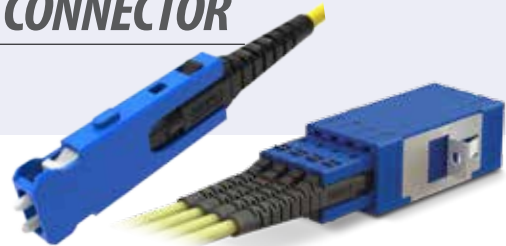

4x  
in QSFP Footprint

- Designed for 4x breakout
- Total 8 Fibers (2Fx4)

Hyper-Scale data center applications are more compact therefore a ruggedized connector is not a primary consideration. The SN® connector provides greater routing and capacity than current hyper-scale data center configurations have today. This increased capacity allows for future growth while not having to change out the entire infrastructure.

CS® is available in serial, parallel, and WDM optical cabling schemes while SN® is available in parallel cabling schemes.



## \*MDI (Media Device Interface)

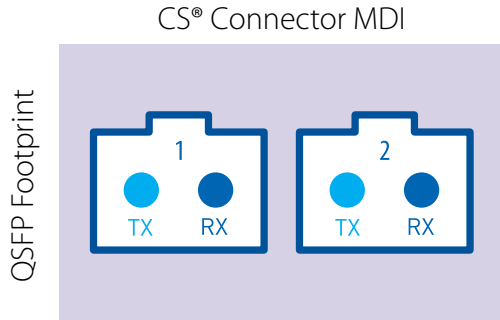

- 2x100G
- 2x200G

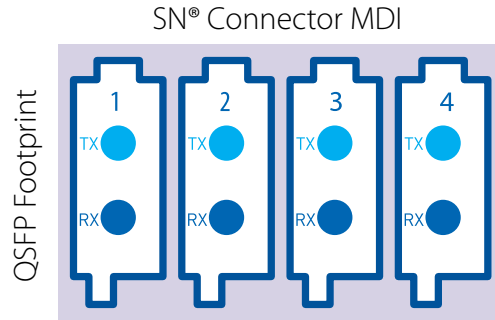

- 4x100G
- 4x200G

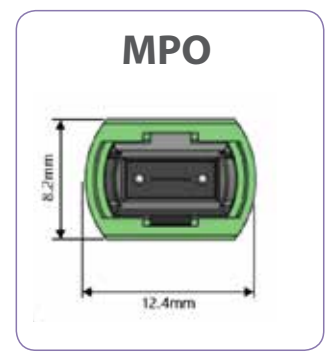
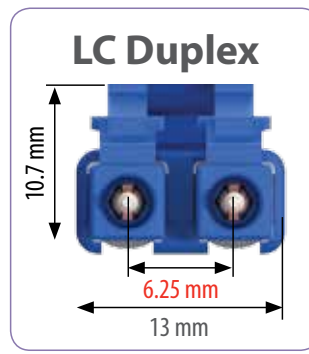
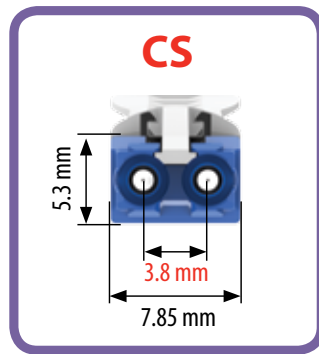
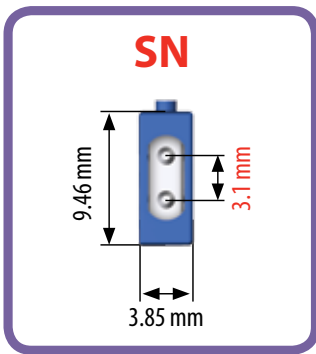

The CS<sup>®</sup> connector was optimized as a robust higher density replacement over the duplex LC connector in both the rack and structured cabling environments.

The SN<sup>®</sup> connector provides increased density over the CS<sup>®</sup> connector, and the ability to do individual breakout at the transceiver. In addition to breakout capabilities at the transceiver, the SN<sup>®</sup> connector allows direct cross connection without the need for additional breakout cables or fiber shuffles that add up to four fiber connections into the overall link. Additional fiber connections add increased insertion loss, creates points of failure, and increases overall cost.

Connector Type	1RU Patch Panel
<b>LC</b>	72-channel / 144-fiber
<b>CS<sup>®</sup></b>	168-channel / 336-fiber
<b>SN<sup>®</sup></b>	192-channel / 384-fiber - 256/264-channel / 512/528-fiber

Both CS® and SN® uses single-mode quality zirconia ferrules which provides optical signal integrity. Easy cleaning and maintenance is similar to what is done today with the duplex LC connector. The CS® connector supports either 2mm or 3mm jacketed cable, where the SN® connector can only support a 1.6mm jacketed cable. In some co-located or enterprise data centers that have point-point connections between different racks, a 1.6mm cable might not be suitable for all applications. The minimum supported jacketed cable thickness requirements would need to be validated with the customer.

The CS® connector is a replacement to current duplex LC connectors which are too large for next generation transceiver interfaces for dual optics engine transceivers, and also facilitates the need for increased connector density in patch panels. CS® is compatible in dual duplex transceivers supporting 2 x 100GE, 2 x 200GE, and 2 x 400GE when they become available. The SN® connector provides a replacement for the MPO connector in quad fiber applications such as PSM4, SR4, DR4 and SR4.2 modules. The SN® connector will support 4 x 100GE (400GBASE-DR4) and 4 x 200GE transceivers when they become available.

## Summary of CS vs. SN data center applications



### CS® Connector - Enterprise Co-Lo, Cloud & Edge

- Serial, Parallel and WDM optical cabling schemes
- Central Network Point of Administration cross-connect
- Trunk cabling to Zone Cabinets, switches and servers
- CS/CS trunk cables
- MPO/MPO trunk cables
- CS/MPO trunk cables
- CS/CS jumpers 2.0mm O.D.
- CS/LC jumpers 2.0mm O.D.
- Patch panel channel counts in 1RU - 128Ch, 144Ch & 160Ch matches up to either 32 channel and 36 channel port counts
- 10G, 40G, 100G, 200G & 400G

### SN® Connector - Hyper-Scale

- Parallel optic cabling schemes
- Central Network Point of Administration cross-connect
- Trunk cabling to Zone Cabinets, switches and servers
- MPO/MPO trunk cables
- SN/SN jumpers 1.6mm O.D.
- Patch panel channel counts in 1RU - 128Ch, 160Ch, 192Ch, 256Ch matches up to either 32 or 64 channel port counts
- 400G

Double Density MSA's reference:

QSFP-DD <http://www.qsfp-dd.com/>

SFP-DD <http://sfp-dd.com/>

OSFP <https://osfpmsa.org/index.html>

**USA**

East Coast +1-508-481-9999  
West Coast +1-858-623-3300  
Texas +1-972-661-9080  
Sales-Americas@senko.com

Mexico & Central America +1-858-623-3300  
Sales-Mexico@senko.com

Brazil and South America +55-21-3736-7065  
Sales-Brazil@senko.com

**Asia-Pacific**

Hong Kong +852-2121-0516  
Shanghai +86-21-5830-4513  
Shenzhen +86-755-2533-4893  
Thailand +66(0)2-163-2798  
Australia +61(0)3 9755-7922  
Sales-Asia-Pacific@senko.com

**Japan**

Yokkaichi City +81-59-352-1121  
Tokyo +81-3-5825-0911  
Sales-Japan@senko.com

**United Kingdom**

UK +44(0) 1256 700880  
Sales-UK@senko.com

**Europe**

**Spain & Portugal**

Sales-Iberia@senko.com

**Germany**

Sales-Germany@senko.com

**Italy**

Sales-Italy@senko.com

**France**

Salesfrance@senko.com

**Other European Countries**

+44(0) 1256 700880  
Sales-Europe@senko.com