

LC TOP ADAPTER True One Piece (TOP) Design 98C Series

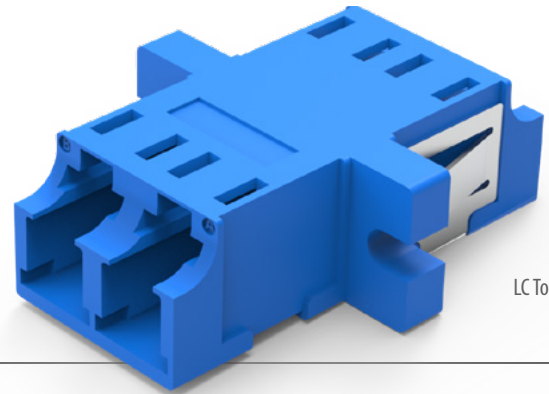

LC Top Adapter

The SENKO LC “True One Piece” Adapter stands out in the fiber optic network landscape for its robust design and high reliability performance. Engineered to fit into the footprint of the SC Adapter, it surpasses the limitations of standard ultrasonically welded two-piece designs, this adapter boasts an exceptional side loading capability that enhances its reliability and durability. The optional laser shutter, available for the simplex version, is a critical safety feature that provides -33 dB protection at 1310 nm, effectively safeguarding users from the dangers of harmful laser radiation. This makes the adapter an ideal choice for environments where safety is a paramount concern.

Available in simplex, duplex, and 12-port versions, the SENKO LC TOP Adapter offers versatility to meet the diverse needs of various applications. Whether it’s deployed in a high-stakes setting where performance and safety cannot be compromised, or utilized for routine operations, the adapter is built to deliver consistent, top-tier performance.

FEATURES

- Robust One piece design ensures durability and longevity
- Superior side loading capability to provide better performance compared to standard ultrasonically welded two-piece designs
- Optional laser shutter (simplex only)
- Simplex, quad and 12 port version available
- Standard SC footprint compatibility ensures a perfect fit without rattle, enhancing stability

APPLICATIONS

- Telecommunications
- Data centers
- Local area networks (LANs)
- Fiber to the home (FTTH)
- Enterprise networks
- Medical equipment
- Industrial applications
- Military and aerospace
- Broadcasting

KEY BENEFITS

- ✓ **SC footprint compatibility**
- ✓ **Enhanced reliability: due to its superior design and construction**
- ✓ **Exceptional durability: engineered to withstand demanding environments**
- ✓ **Versatile applications: suitable for both high-stakes and everyday use scenarios**

Mechanical Data

	Value
Durability	500 matings
Fixing Method	Snap fit (<i>adapter without flange</i>) or screw and nut (<i>adapter with flange</i>)
Housing Material	Plastic
Alignment Sleeve Material	Zirconia
Dust Protection Method	Removable dust plugs
Fiber Count	Simplex, duplex or 12 port
Adapter Design	One piece (<i>weldless flange</i>)

Optical Data

	Value
Typical Insertion Loss (dB)*	0.10
Max. Insertion Loss (dB)*	0.20

* Based on master grade jumper to low loss random mating test

Environmental Data

	Value
Operating Temperature	-40°C to +75°C
RoHS Compliance	Yes
REACH Compliance	Yes
Humidity Resistance	95%

LC TOP ADAPTER

True one piece (TOP) design, 98C series

Adapter Drawing

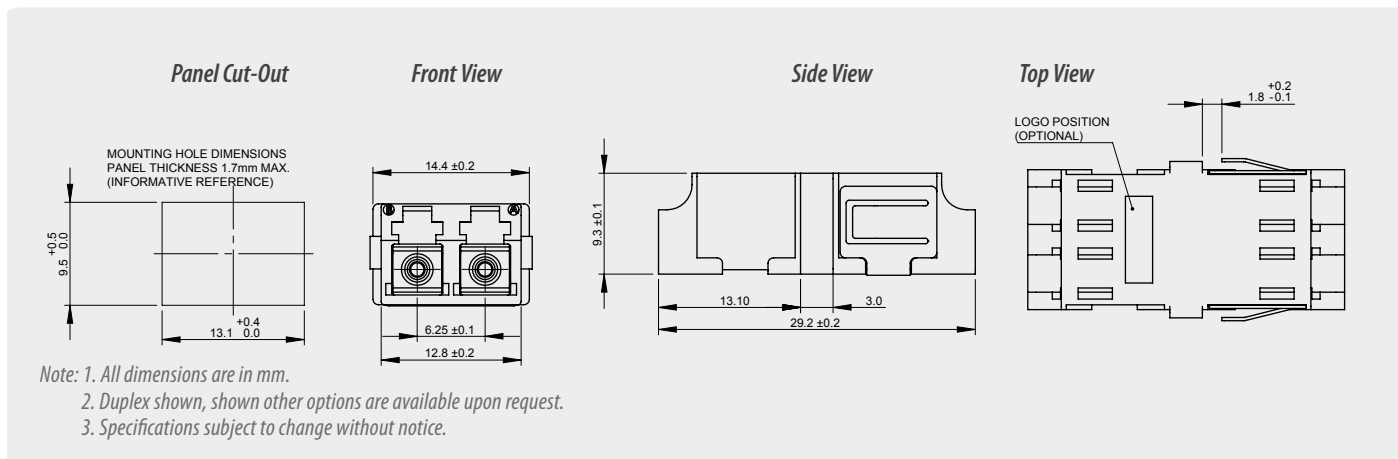

12-Port Adapter Drawing

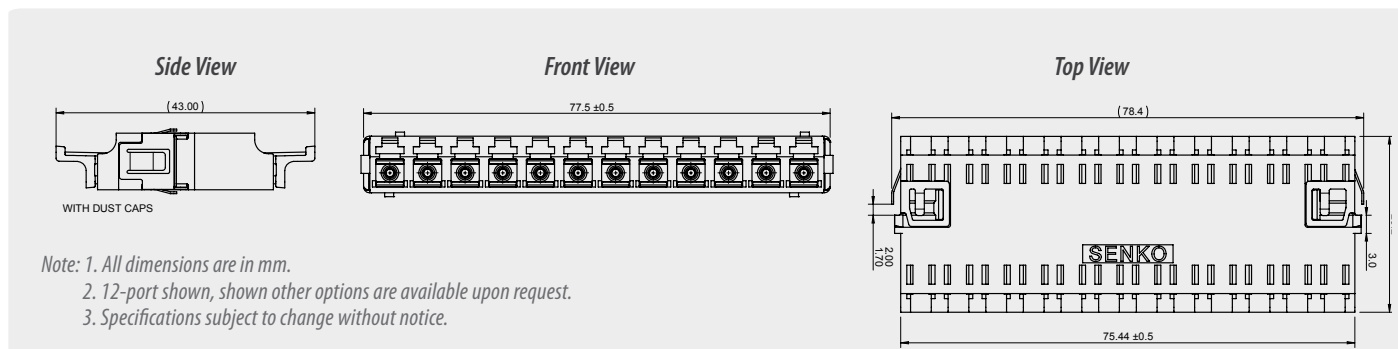

ORDERING

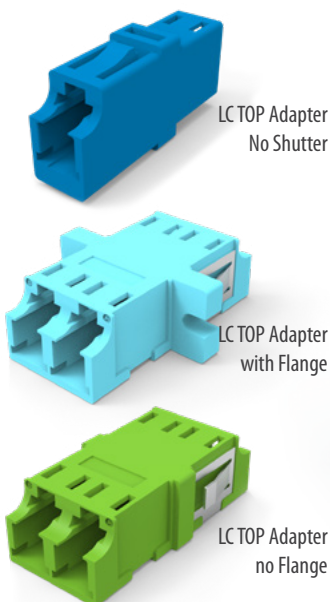

CODE	TYPE	COLOR	SLEEVE TYPE	SHUTTER
98C	1 Simplex	1 Blue	1 Zirconia	N No Shutter
	3S Duplex with Flange	2 Black		A Internal Shutter (simplex only)
	4S Duplex No Flange	3 Green		
	AS 12 Port with Flange	7 Violet OM4 (MOQ Req)		
	BS 12 Port No Flange	8 Beige		
		9 Aqua OM3		

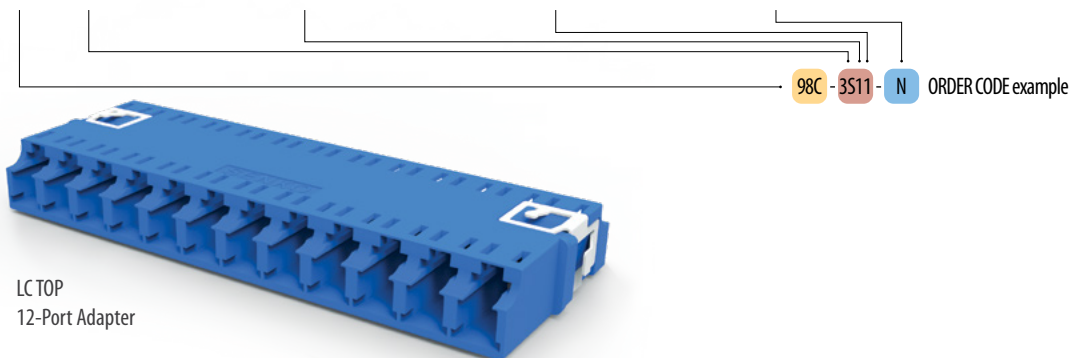

Accessories - Production/Cleaning

Smart Cleaner™
Cassette
PN: SCK-CC-100

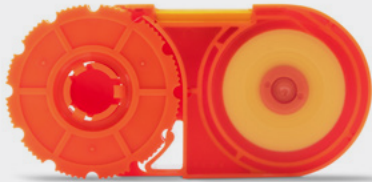

Smart Cleaner™
Mini 1.25 mm Clicker
PN: SCK-SS-M-C125
Refill PN: SCK-SS-CS-R



Smart Cleaner™
1.25 mm Clicker
PN: SCK-SS-CS
Refill PN: SCK-SS-CS-R



**1.25 mm NEOCLEAN
Cleaning Stick**
PN: CSK-01

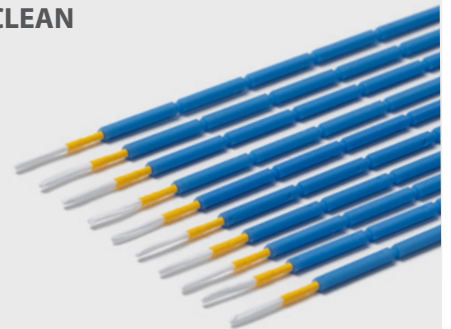

Accessories - Interferometry

SUMIX Manta W+ Inspection Scope
PN: SMX-Manta-W+



- Inspects 12 fiber in 2.6 seconds, 24 fiber in 4.5 seconds
- 0.5µm defect detection
- Inspection tips for MPO, CS, SN, LC available

SUMIX Max QM+ Inspection Scope
PN: MAX-Quantum



- Inspects 12 fiber in 2.6 seconds, 24 fiber in 4.5 seconds
- 0.5µm defect detection

SENKO[®]

Advanced Components

sales@senko.com
1-858-623-3300

senko.com/contact