

# Get higher density with **CS<sup>®</sup> CONNECTOR**

LC latch features **prohibits** vertical stack density

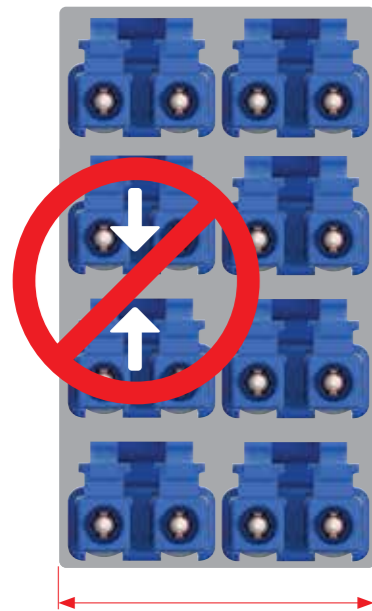
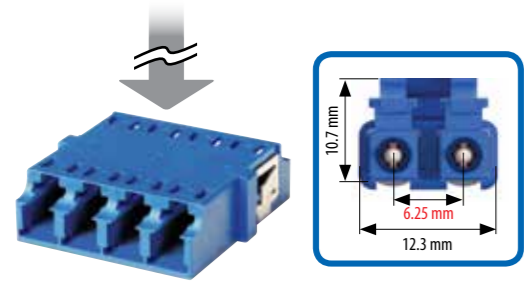

28.5 mm

**CS<sup>®</sup> CONNECTOR** creates vertical/horizontal density

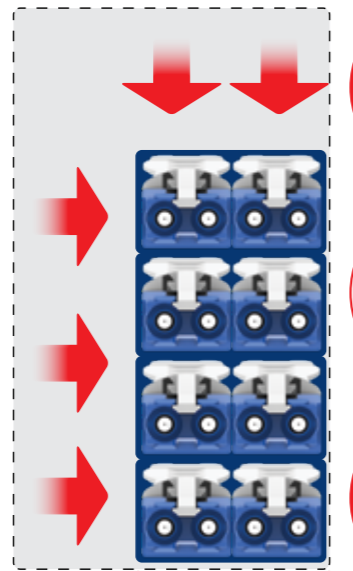
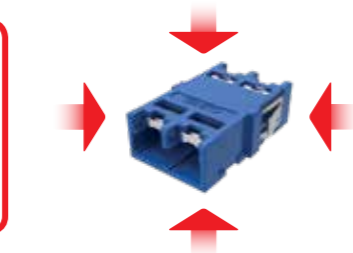
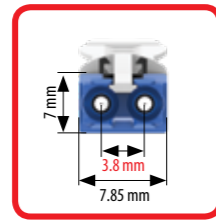

17.5 mm

**30% VERTICAL SPACE SAVING**

**Double the density overall**

**40% SPACE SAVING**

**1U only**

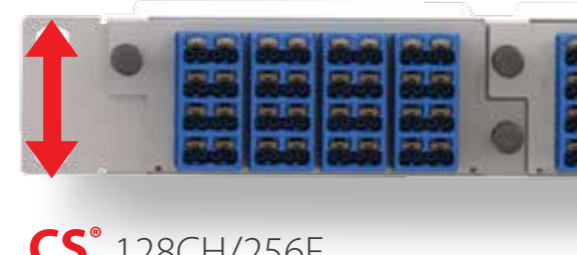

**CS<sup>®</sup> 128CH/256F**  
Cassette Module Patch in 1RU

**2U at least**

**LC 128CH/256F** Cassette Panel in 2RU

## CS<sup>®</sup> CONNECTOR Push-Pull Tab Variants

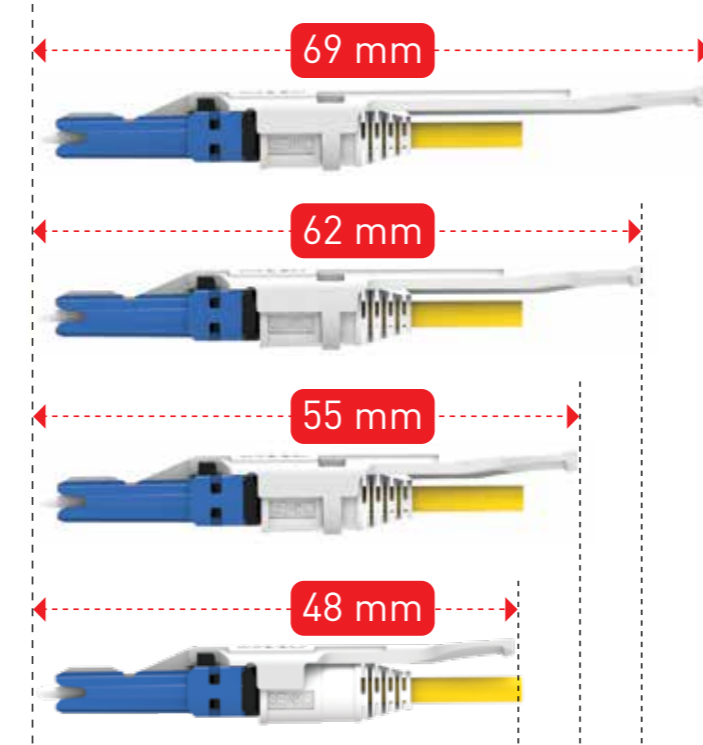

### CS<sup>®</sup> CONNECTOR Part Number

CONNECTOR TYPE	FERRULE SIZE	HOUSING COLOR	BOOT TYPE	BOOT COLOR	TAB LENGTH	TAB COLOR
601 CS Connector (2F)	151 SM Standard	1 Blue	2 2.0 mm	1 White	48 48 mm	W White
		5 Aqua	3 3.0 mm		55 55 mm	
	251 MM Standard	6 Heather violet			62 62 mm	
		7 Lime			69 69 mm	

CONNECTOR TYPE	FERRULE SIZE	HOUSING COLOR	BOOT TYPE	BOOT COLOR	TAB LENGTH	TAB COLOR	
611 CS Connector (2F) APC	153 APC Premium	3 Green (APC)	2 2.0 mm	1 White	48 48 mm	W White	
			3 3.0 mm	6 Green	55 55 mm		
						62 62 mm	
							69 69 mm

611 - 153 - 321 - 48W ORDER CODE example

### CS<sup>®</sup> ADAPTER Part Number

CONNECTOR TYPE	FLANGE	HOUSING COLOR
681 CS Single Channel (2F) Adapter	1 With Flange	3 Green
682 CS Dual Channel (4F) Adapter	2 No Flange	5 Lime (OMS)
684 CS Quad Channel (8F) Adapter		7 Heather Violet (OM4)
		8 Beige
		9 Aqua

681 - 13 ORDER CODE example

## CS<sup>®</sup> ADAPTER Variants

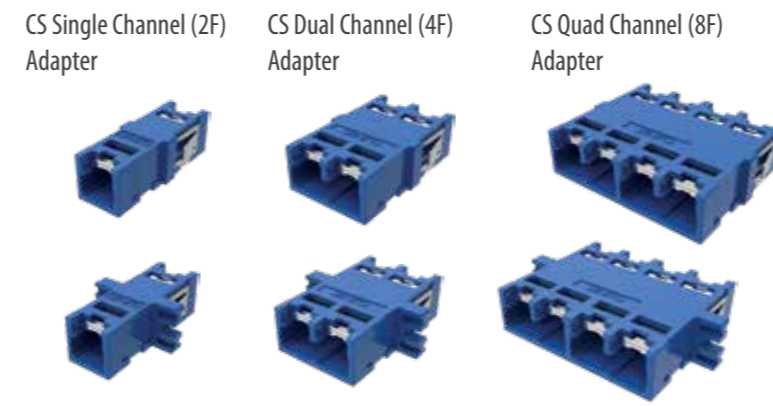

### CS<sup>®</sup> Tool



**SENKO<sup>®</sup>**  
Advanced Components

**CS<sup>®</sup> CONNECTOR**

Reach higher density with CS<sup>®</sup> Connector

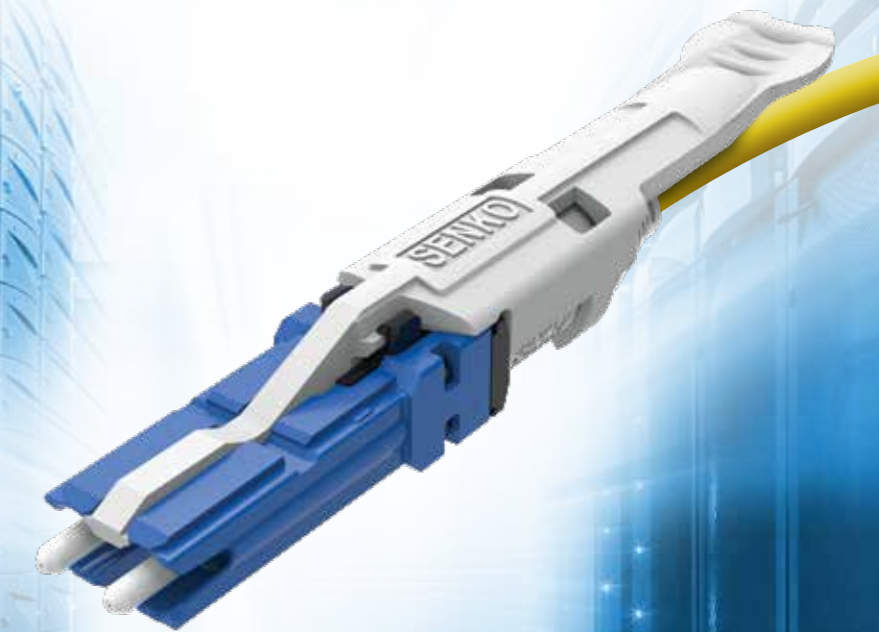

**2x 200G CWDM 4 QSFP-DD/OSFP**

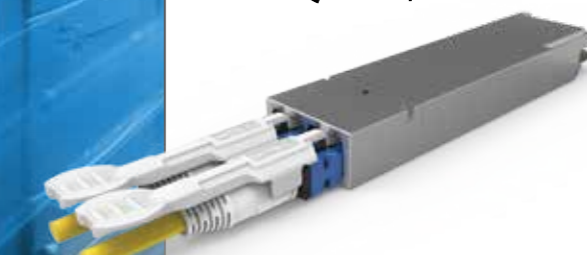

2 Duplexes in 1 Transceiver

**CS CONNECTOR VS. LC DUPLEX**

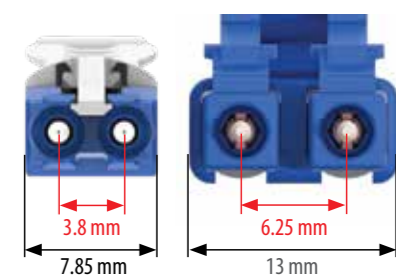

CS Connector LC Duplex

### SENKO ADVANCED COMPONENTS, INC.

**America**  
USA EAST 1-888-32-SENKO  
USA WEST 1-858-623-3300  
TEXAS 1-972-661-9080  
Sales-Americas@senko.com

**South America**  
BRAZIL +55-21-3736-7065  
Sales-Brazil@senko.com

**Asia**  
HONG KONG +852-2121-0516  
SHANGHAI +86-21-5830-4513  
SHENZHEN +86-755-2533-4893  
Sales-Asia@senko.com

**Asia Pacific**  
AUSTRALIA +61 (0) 3 9755-7922  
Sales-Asia-Pacific@senko.com

**Middle East North Africa**  
DUBAI +971 4 8865160  
Sales-MENA@senko.com

**Europe**  
FRANCE +44 7939364565  
Salesfrance@senko.com  
GERMANY +49(0)15117683072  
Sales-Germany@senko.com  
ITALY +39 338 8919089  
Sales-Italy@senko.com

**POLAND** +44 (0) 7796444488

**SPAIN & PORTUGAL** +34 678042829  
Sales-Iberia@senko.com  
UK +44 (0) 1256 700880  
Sales-UK@senko.com  
OTHER +44(0) 1256 700880  
Sales-Europe@senko.com

**Japan**  
TOKYO +81 (0) 3 5825-0911  
Sales-Japan@senko.com

CALL 1-888-32-SENKO

www.senko.com

www.senko.com

NEW Duplex connector optimized for 400G new generation Data Center

40% size reduction compared to LC Duplex

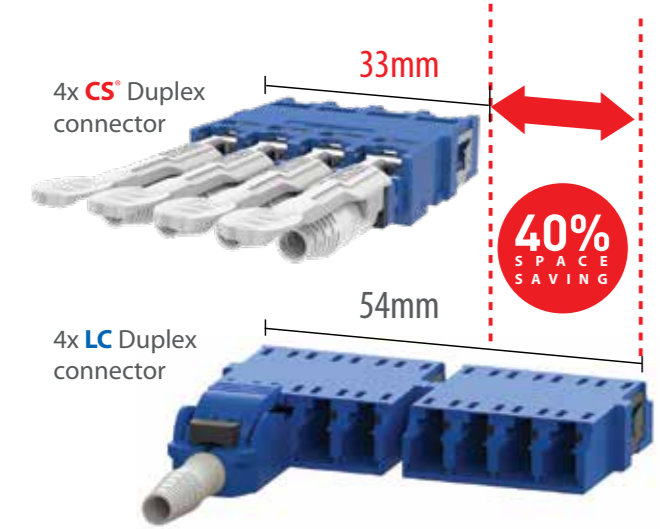

30% vertical density reduction compared to LC Duplex

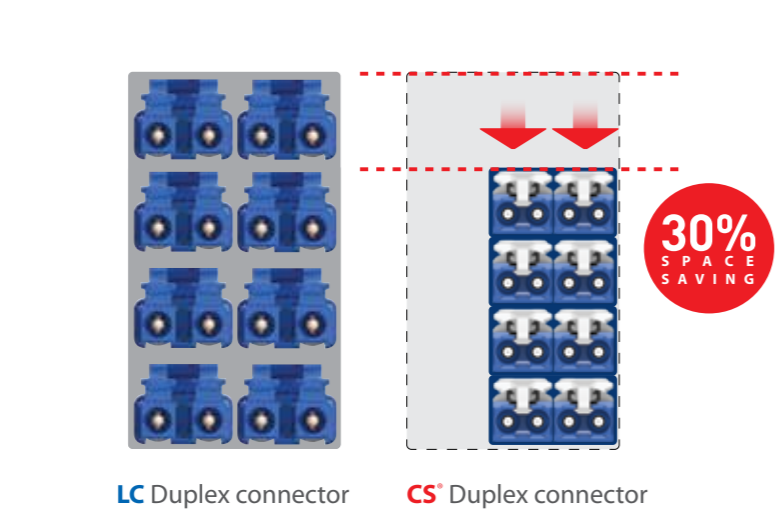

Proven 1.25mm Ferrule technology

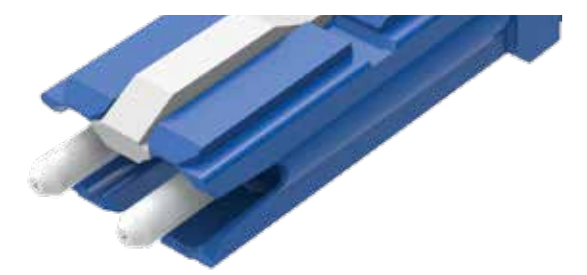

Push/Pull tab

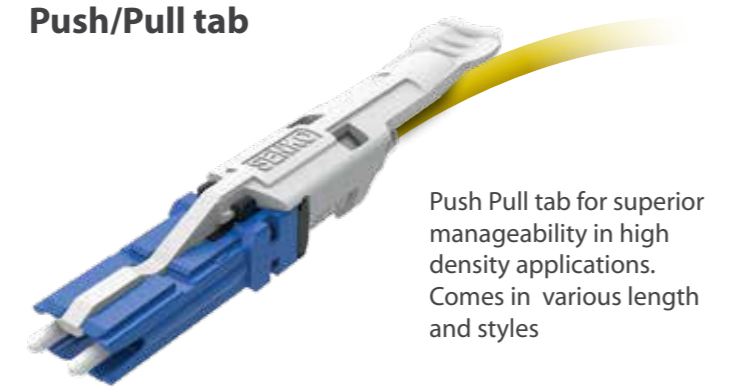

Designed for OSFP/QSFP-DD Break out application



Features

- Double the density compared to conventional LC
- Designed for OSFP/QSFP-DD Break out application
- Proven 1.25mm Ferrule technology
- Push/Pull tab
- IEC random mating Grade B

QSFP-DD/OSFP with 1U 32-port Switch 32-port is inserted

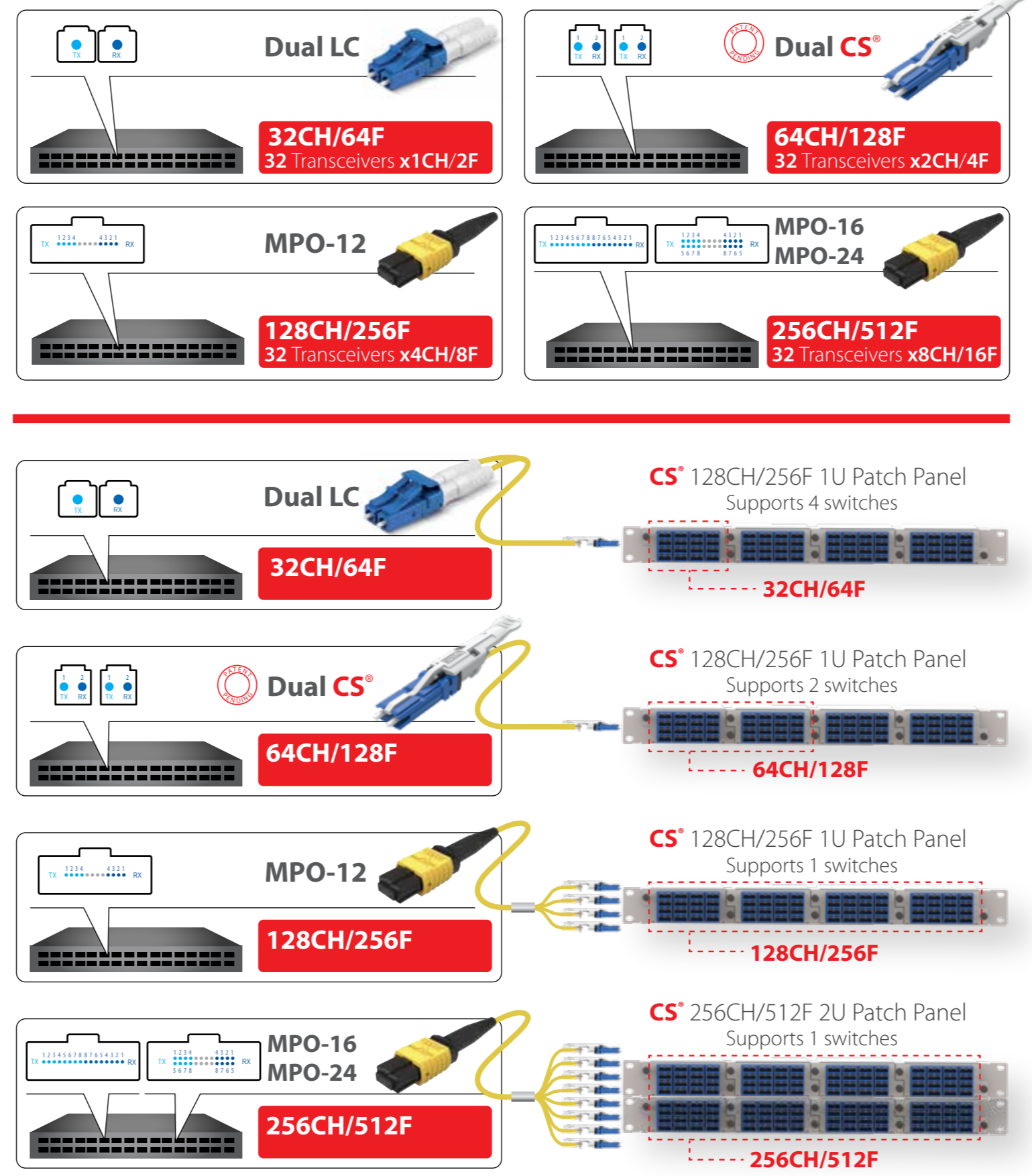

## 45RU Rack Comparison

Double your density with CS<sup>®</sup> CONNECTOR

Generic LC

CS<sup>®</sup> CONNECTOR

with LC

Total Capacity  
**2048 CH**  
**4096 F**  
(single sided rack/cabinet)

Total 7RU  
Cable Management  
Space

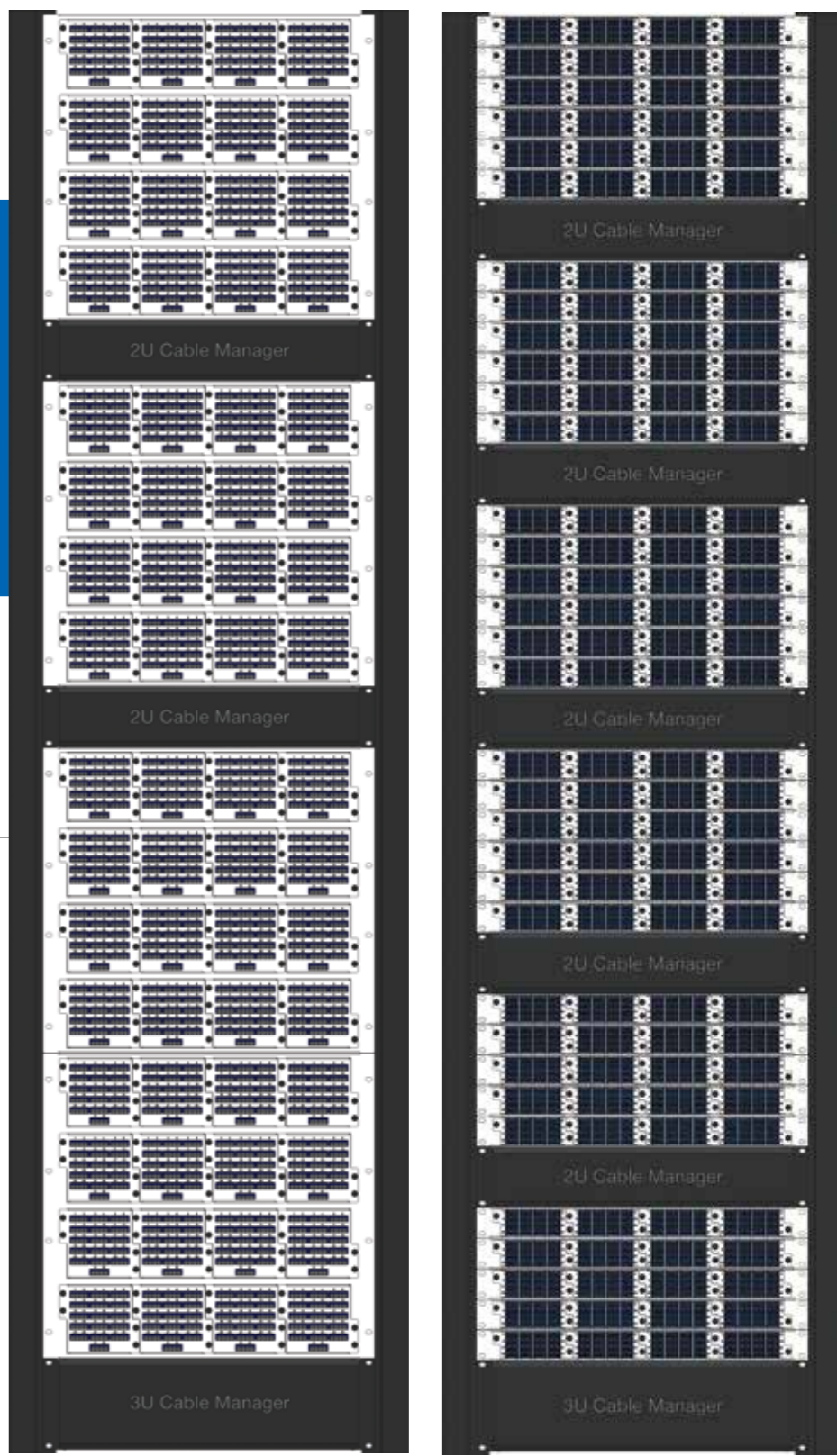

with CS<sup>®</sup>

Total Capacity  
**4352 CH**  
**8704 F**  
(single sided rack/cabinet)

Total 13RU  
Cable Management  
Space

\*Note that the 3 RU wire manager is installed on the bottom rack base plate and the remaining 1 RU space at the bottom of the rack.